

## Performance Evaluation of Wired and Wireless Local Area Networks

Prof. Satish K. Shah<sup>1</sup>, Ms. Sonal J Rane<sup>2</sup>, Ms. Dharmistha D Vishwakarma<sup>3</sup>

<sup>1,3</sup>Department of Elect. Engg., Faculty of Tech. & Engg., M.S. University of Baroda, Kalabhavan, Vadodara-390001, Gujarat, India

<sup>2</sup>Dept. of Elect. Engg., Faculty of Tech. & Engg., M.S. University of Baroda, Kalabhavan, Vadodara-390001, Gujarat, India

**Abstract**—Very large scale integration of complex circuits on to a smaller chip demands for the evolution of high speed computer networks. The traditional wired network constraints like mobility and expensive cabling. But wireless communication is a flexible data communication system implemented as an extension to or as an alternative for wired communication. The bandwidth and the services provided by the wireless communication networks are similar to that provided by the wired networks. Computing the viability and performance of computer networks in real can be very expensive task. In this paper, performance of wireless and wired networks as well as comparison is evaluated using OPNET simulation tool. For wired network, collision count, traffic received, delay, throughput is studied while for wireless network, data dropped, traffic received, media access delay, and throughput is studied. For comparison of both wired and wireless networks, the performance parameters throughput is investigated. All these performance is carried out by varying number of users.

**Keywords**—Ethernet, WLAN, OPNET, Throughput, Delay

### I. INTRODUCTION

Networks (Wired and Wireless) have grown like weed over the past few decades providing a pace to the means of accessing network resources. Therefore, it is vital to have an accurate and a reliable generic platform to enable network. The wired Networks provide a secure and faster means of connectivity. The performance of the wired Ethernet is very sensitive to the number of users, offered load, transmission links while wireless is also very sensitive to the number of users, offered load as well as physical characteristics, data rate, packet size and so on. We can compare wired and wireless networks in the area of installation, cost, reliability, performance, security, mobility. As networks are being upgraded from scratch all over the world, network planning is becoming most important. Computing the viability and performance of networks in real can be very expensive and painstaking task. To ease and comfort the process of estimating and predicting a network techniques are widely used and put into practice. A variety of simulation tools like Qualnet, NS2, Netsim and OPNET are available for the purpose of modelling and simulation but the choice of a simulator depends upon the features available and requirements of network application. Among the various network simulators OPNET provides the industry's leading environment for network modelling and simulation. It allows to design and study communication networks, devices, protocols, and applications with flexibility and scalability. It provides object oriented modelling approach and graphical editors that mirror the structure of actual networks and network components. The analysis helped to estimate and optimize the performance of wired and wireless networks using proposed optimization techniques [1].

This paper has been organized as follows: Part I deals with Introduction, Part II and Part III deal with the brief description of IEEE 802.11 and IEEE 802.3, Part IV deals with the simulation set-up and result with the performance metrics being focused upon and in the last section the paper has been concluded.

### II. WIRED NETWORK : IEEE802.3

Wired local area networks include several technologies like Ethernet, token ring, token bus, Fibre distributed data interface and asynchronous transfer mode local area networks [2]. Standardized in IEEE 802.3, Ethernet has largely replaced competing wired LAN technologies. The Ethernet is a working example of the more general Carrier Sense, Multiple Access with Collision Detect (CSMA/CD) local area network technology. The Ethernet is a multiple-access network, meaning that a set of nodes sends and receives frames over a shared link. When the two devices transmit at the same time the collision can occur. This collision generates a jam signal that causes all nodes on the segment to stop sending data, which informs all the devices that a collision has occurred. The "carrier sense" in CSMA/CD means that all the nodes can distinguish between an idle and a busy link. The "collision detect" means that a node listens as it transmits and can therefore detect when a frame it is transmitting has interfered (collided) with a frame transmitted by another node. The Ethernet is said to be a 1-persistent protocol because an adaptor with a frame to send transmits with probability 1 whenever a busy line goes idle.

### III. WIRELESS NETWORK : IEEE 802.11

IEEE 802.11 is a recent standard developed for wireless local area networks (WLANs). IEEE 802.11 is a multiple access protocol in which stations in the network must "compete" for access to the shared communications medium to transmit data. IEEE 802.11 uses a carrier sensing capability to determine if the communications medium is currently being used [3]. If two or more stations in the network transmit at the same time (i.e., a collision occurs), stations retransmit their

data after random periods of time as in Ethernet. Wi-Fi (Wireless Fidelity) Technology, referred as the 802.11 communications standard for WLAN is the popular wireless networking technology that uses radio waves to provide wireless high-speed Internet and network connections.

The 802.11 data link layer is divided in two sub layers: Logical Link Control (LLC) and Media Access Control (MAC). LLC is the same as in 802 LAN allowing for very simple bridging from wireless to wire networks. MAC is different to WLANs. The first method in MAC is CSMA with collision avoidance protocol. This protocol is to ask each station to listen before action. If the channel is busy, the station has to wait until channel is free. Another method in MAC is called RTS/CTS to solve hidden-Node problem [4].

#### IV. SIMULATION SET-UP AND RESULTS

The Ethernet is a multi-access network, meaning that a set of nodes sends and receives frames over a shared link. It implements the capability of transmitting and monitoring a connected bus link at a same time. It has full duplex capability. Here we setup Ethernet network model with star topology and data rate of 10Mbps using OPNET [5] with 25, 50,100 users. Scenario for wired network, created for Ethernet using 50 nodes, is shown in Figure 1(a). The Wireless LAN model suite includes the features of the IEEE 802.11 operating at a data rate of 10Mbps in a star topology using OPNET Modeler 14.5 is as shown in Figure 1(b). The network also expanded for the 25 and 100 users.

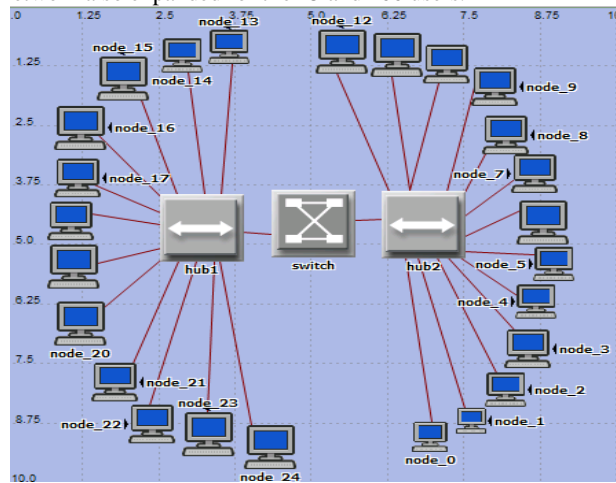

Fig. 1(a) Ethernet network model for 50 Ethernet stations

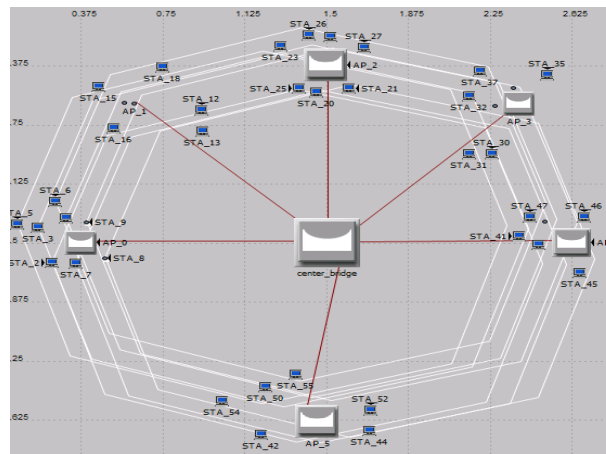

Fig.1(b) Wireless network model for 50 users

In this section, the wireless and wired networks performances are analysed using OPNET [6] simulation. In wired and wireless network, comparison is done by varying number of users. The performance metrics evaluated are throughput, delay, data dropped, traffic received, collision count, retransmission attempts.

- **Throughput:** network throughput is the average rate of successful message delivery over a communication channel. It is measured in bits per second (bit/s or bps) or in data packets per second or data packets per time slot.
- **Retransmission attempts:** Total number of retransmission attempts by all WLAN MAC in the network until either packet is successfully transmitted or it is discarded as a result of reaching short or long retry limit.
- **Collision Count:** Total number of collisions encountered by this station during packet transmissions [5].
- **Data Dropped:** Total higher layer data traffic (in bits/sec) dropped by the all the WLAN MACs in the network as a result of consistently failing retransmissions. This statistic reports the number of the higher layer packets that are

dropped because the MAC couldn't receive any ACKs for the (re)transmissions of those packets or their fragments, and the packets' short or long retry counts reached the MAC's short retry limit or long retry limit, respectively [5].

From the Figure 2 it is observed that the received bit rate is approximately equal to the sent bit rate for small number of users. As the number of user increases, more traffic was sent and received. As the number of users increases the hub switch becomes overloaded and cannot deliver all the traffic that it received.

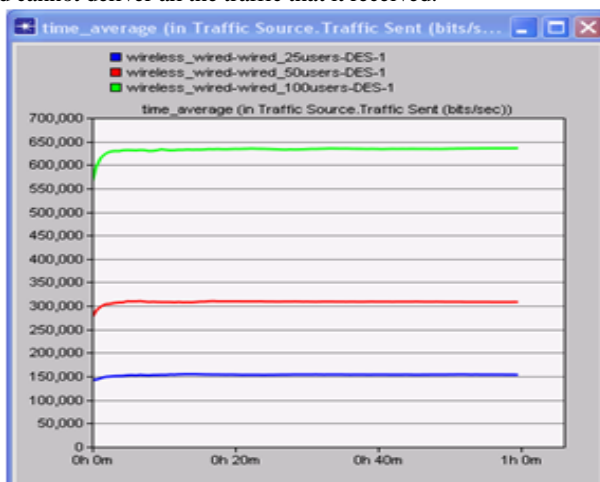

Fig. 2(a) traffic sent (bits/sec) of different scenarios having 25,50,100 users

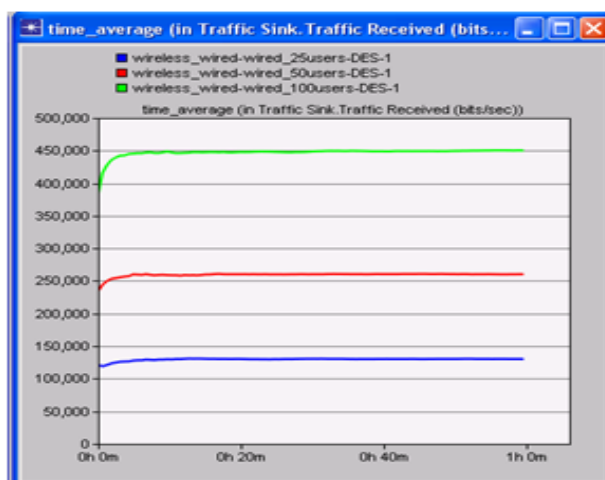

Fig. 2(b) Traffic received (bits/sec) of different scenarios having 25, 50, 100 users

Discrepancies between send and receive rates can be accounted for by inspecting the collision count statistic as shown in Figure 3. In Figure 4, it is observed that maximum throughput is achieved in the case when less number of users is deployed. As the number of users increases, more number of the higher layer packets that are dropped because the MAC couldn't receive any ACK for the (re) transmissions of those packets or their fragments, and the packets' short retry limit or long retry limit, respectively. With less number of users, the overall performance of the system increases as data transmission will be faster.

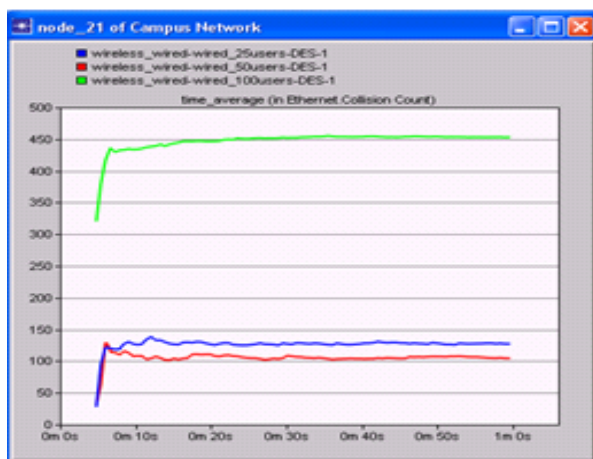

Fig. 3 Collision count in wireless network

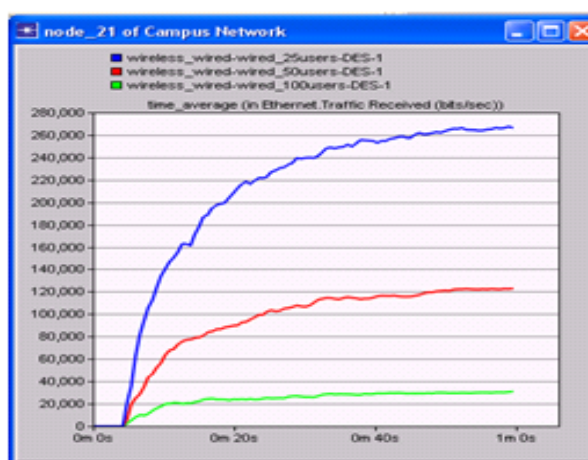

Fig.4 Throughput (bits/sec) of different scenarios on node 21 for Ethernet

As the number of users increases in WLAN, data dropped in wireless LAN increases. Some of the packets that were sent collided and require retransmissions. So as the users increase, retransmission rate increases for the more number of users which is shown in Figure 5(a) and Figure 5(b) respectively. As the number of user increases, collision between the user data increases and the retransmissions of the user increases which cause for the degradation in the performance of wireless network. It can be observed from Figure 6 that as the number of users increases from 25 to 100 the performance of WLAN decreases.

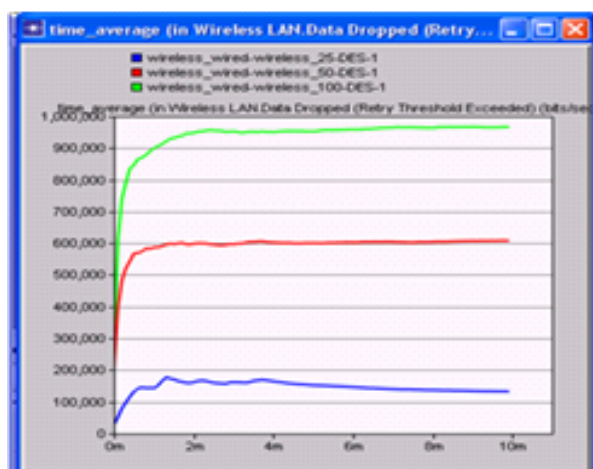

Fig.5 (a) Data dropped for different scenarios for Wireless LAN

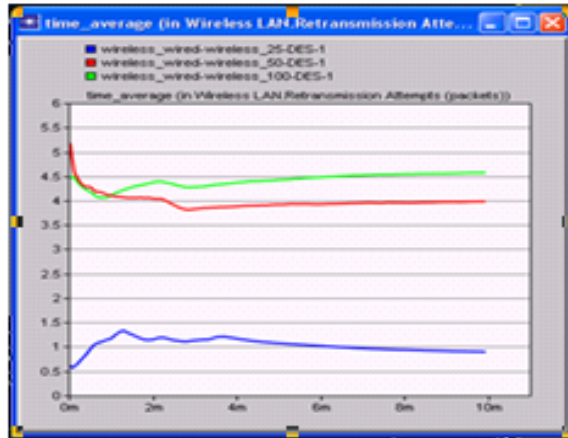

Fig. 5(b) Retransmission attempts of different scenarios for Wireless LAN

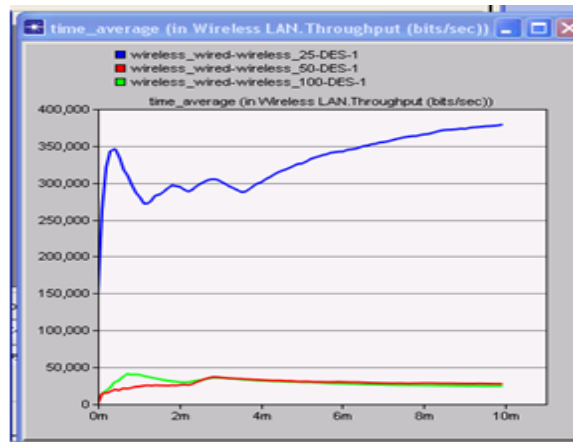

Fig.6 Throughput (bits/sec) of different scenarios for Wireless LAN

Throughput comparison of wired and wireless network is performed for the number of users of 25, 50, and 100 with the data rate of 10 MBPS for both the network. The performance of the networks measured using performance of the random node present in the network. While comparing throughput of Ethernet (wired) in blue color and WLAN (wireless) in red color in Figure 7(a) ,(b),(c) for 25 users on node\_07, for node 37 in 50 users scenario and node 97 for the scenario with 100 users respectively. With less number of users, the overall performance of the system increases as data transmission will be faster. Also it is observed that the throughput of Wireless LAN is greater than throughput of Ethernet for less number of users. As the number of user increases, throughput of WLAN becomes poor because of slow transmission speed and data dropped. When the number of users is increased, the throughput decreases for wireless systems, these effects associated with wireless transmission limit the SNR (Signal to Noise Ratio) and bandwidth of the received signal, and therefore the maximum number of bits that can be sent.

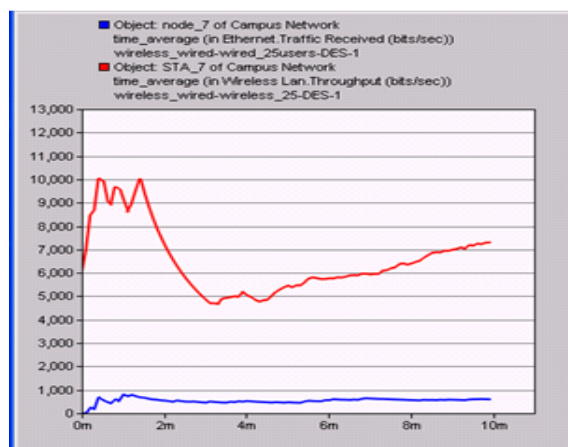

Fig. 7(a) Throughput of Ethernet and WLAN on node 07

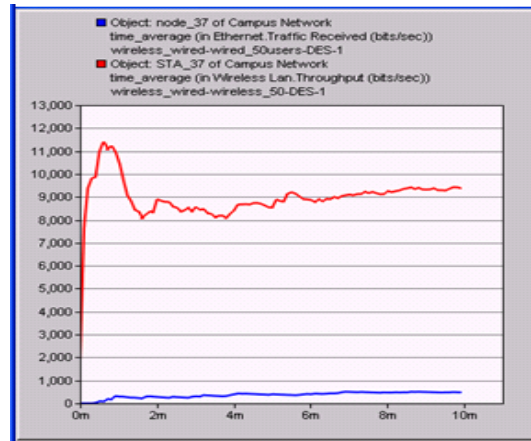

Fig.7(b) Throughput of Ethernet and WLAN on node 37

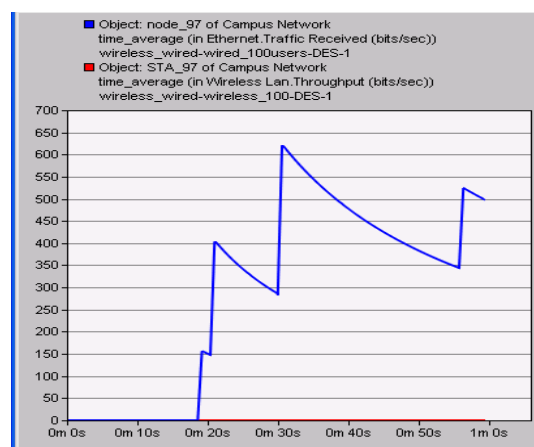

Fig. 7(c) Throughput of Ethernet and WLAN on node 97

## V. CONCLUSIONS & FUTURE WORK

In this paper set of simulation experiments performed in OPNET simulator that compares wired and wireless network performances. For the less number of users wireless network performs better than the wired network for the same data rate of packets. While as the number of user increases the performance and throughput degradation occurs for wireless network than the wired network with same speed due to the transmission limit, SNR (signal to noise) and bandwidth of the received signal. As the number of users or load increases beyond some limit on wireless network can cause the collisions among the packets sent by the users and due to that the retransmissions occurs in the wireless network which degrade the performance. So to improve the overall performance of the system it is better to use hybrid network which is the combination of both wired and wireless network.

## VI. ACKNOWLEDGMENT

Authors are thankful to Dept. of Elect. Engg., Faculty of Tech. & Engg., M.S.University of Baroda for technical help in doing this work.

## REFERENCES

- [1]. Dr. R.K.Bansal,Vikas Gupta,Rahul Malhotra, ” Performance analysis of wired and wireless LAN using soft computing techniques-A review”, Global Journal of Computer Science and Technology, Vol. 10 Issue 8 Ver.1.0 September 2010.
- [2]. Ikram Ud Din, Saeed Mahfooz and Muhammad Adnan, —Performance Evaluation of Different Ethernet LANs Connected by Switches and Hubs, European Journal of Scientific Research, vol. 37 No. 3, pp. 461-470, 2009.
- [3]. Jia Wang and Srinivasan Keshav, ”Efficient and Accurate Ethernet Simulation”, Proc. Of the 24th Conference on Local Computer Networks (LCN’99), pp. 182-191, 1999.
- [4]. Mohammad Hussain Ali and Manal Kadhim Odah, —Simulation Study of 802.11b DCF using OPNET Simulator, I Eng. & Tech. Journal, vol.27, No6, 2009, pp:1108-1117, 2009
- [5]. OPNET Technologies, www.opnet.com
- [6]. Constantinos Hilaris1 and Anastasios Politis2 , ” Simulations of various IEEE 802.11b network configurations for educational purposes”