

Design of DSP Base Controlled Power Supply on Synchronous Rectifier

Kishori V. Sangani¹, Vinod P. Patel², Sunil B. Bhatt³

^{1,3}B. H. Gardi College of Engg. & Technology, Rajkot, India.

²AMTECH Electronics (I) Ltd, Gandhinagar, India.

Abstract:- Synchronous rectification is a commonly used technique to improve the efficiency of DC/DC converters with low (30V) output voltages and high output currents. Use of a synchronous rectifier in place of diode bridge rectifier because in low voltage application the conduction losses of diode bridge contributes significantly to the overall power loss in a power supply compared to synchronous rectifier. Control of the synchronous rectifiers in forward converters has been accomplished in many different ways, from self-driven to complexly controlled techniques. Most existing control techniques allow the synchronous rectifier's body diode to conduct for some small time interval, thus degrading efficiency. In this synchronous rectifier the PWM techniques are used so the power switches are switched at high frequency which is reduce the size of transformer and overall size, weight and cost. The AC/DC converters called also PWM rectifiers provide synchronous rectification or active filtering improving electrical power quality. The design process of the PWM (pulse width modulation) rectifier has been described. The practical realization of the voltage and current sensors as well as control electronics and the protection systems has been presented. Voltage Oriented Control has been implemented into the DSP to control the synchronous rectifier. The simulation of whole system will do in PSIM (power simulation) software and after examine the simulation results the whole scheme will implement in hardware. PWM waveform generated using CCS (code composer studio) software for DSP (digital signal processing) programming.

Keywords:- Synchronous rectification, low voltage high current, DSP based controlling, voltage control method, PI controller, phase shifted full bridge IGBT inverter.

I. INTRODUCTION

Active rectification, or synchronous rectification, is a technique for improving the efficiency of rectification by replacing diodes with actively controlled switches such as transistors, usually power MOSFETs or power BJTs. Synchronous rectifiers can improve the efficiency of switched –mode power supplies, particularly in low –voltage low power application. The next generation of portable products, such as personal communicators and digital assistants, will have to provide at least 12 hours of operation between battery chargers. Most of the progress toward this 12 hours goal must come from radio frequency (RF), computer and battery technology, because power supply performance is approaching a limit. Typical conversion efficiencies already exceed 95%. Still the power supply must squeeze a battery for all it is worth. A key element in this task, especially at the low output voltages that future microprocessor and memory chips will need, is the synchronous rectifier. A synchronous rectifier is an electronic switch that improves power conversion efficiency by placing a low resistance conduction path across the diode rectifier in a switched mode regulator. Metal oxide semiconductor field effect transistor (MOSFETs) usually serves this purpose but bipolar transistors and other semiconductor switches can be considers for typical applications. The forward voltage drop across a switched mode rectifier is in series with the output voltage, so losses in this rectifier determine efficiency almost entirely. As supply voltage decreases the degrees the design of rectifiers requires more attention because the forward voltage drop constitutes an increasing fraction of the output voltage. The race to new voltage levels proceeds in jumps as each major chip manufacture brings successive fabrication processes on line. Currently, research indicates a V_{cc} of 1.1 V [2].

The increasing number of the modern power electronics converters is controlled by microprocessor-based systems. The dynamic development of the microprocessor techniques results from the numerous advantages of the digital systems. Stability of the parameters, easy modifications of the control algorithms, the possibility of implementation of advanced control techniques as well as providing diagnostic functions are the major features of digital control devices. Nowadays modern digital control units have overtaken all control tasks. In contrary to diffuse analog electronics, digital processing devices are integrated on one small evaluation board. Besides the fast digital signal processor (DSP), the evaluation boards include analog-to-digital converter, input/output systems and memory. The DSP- based kits are specialized to realize control algorithms mostly for

the intelligent motion control applications. Hence they are equipped with the peripheral PWM modules to provide the firing pulses for the power converters. Because of their small size and high functionality the DSP boards have become the integral part of the controlled device, being the unified, self-sufficient, embedded system [3].

The paper presents a detailed analysis of the modulation scheme, discusses results on a three- phase 415 V, 1 Kw laboratory prototype converters [4].

II. DSP BASED CONTROLLED POWER SUPPLY ON SYNCHRONOUS RECTIFIER

Linear regulator often plays important role in implementing synchronous rectifier in power supply capable of constant voltage/current control. It always provides lots of advantage such as low ripple noise, low EMI, good regulation, ease control strategy. However due to bulky size, low efficiency switch mode technique has become an inevitable development trend for raising the power density, power efficiency and dynamic performance. The full bridge converter is one of the isolated converter topology that use in high power rating. The block diagram of it is shown in fig 1. The feedback signal of voltage is given to the DSP control card for control and protection purpose.

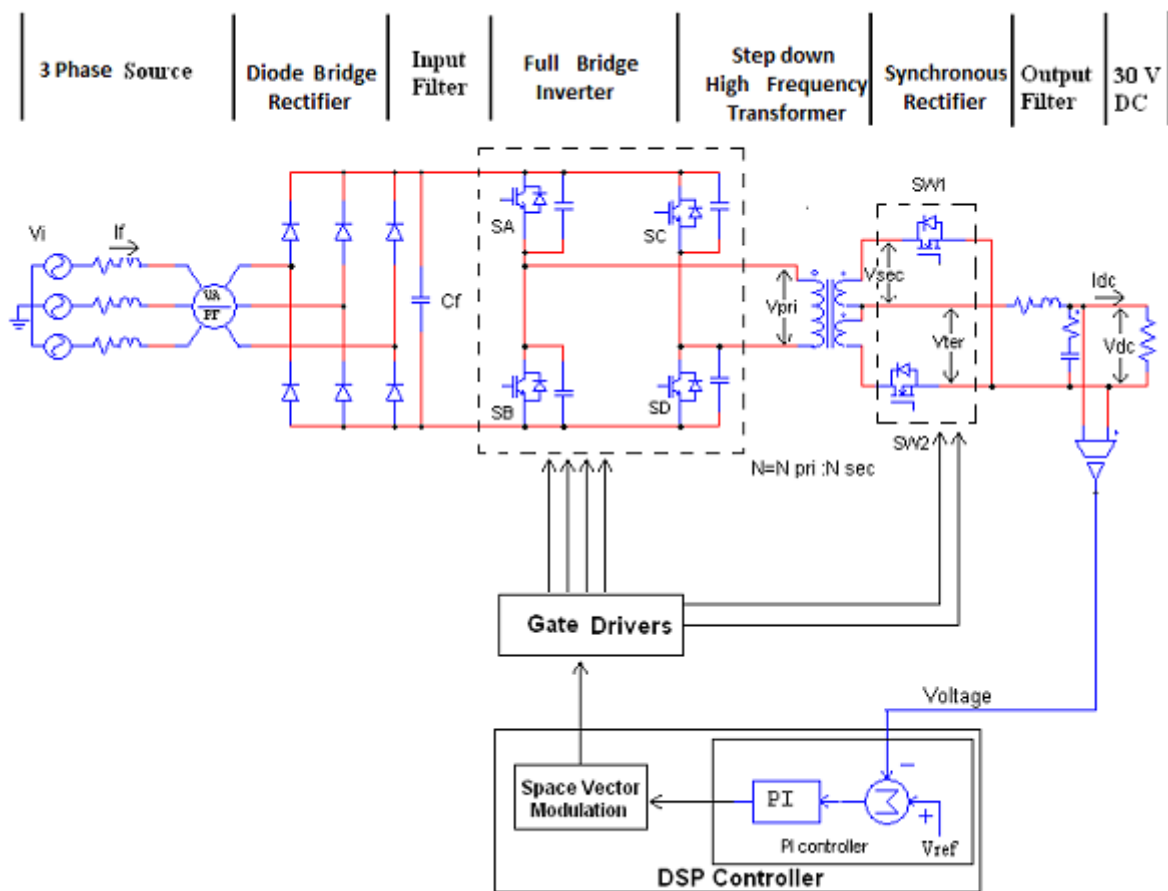

Fig. 1: DSP based controlled Power supply on synchronous rectifier

III. DSP BASED CONTROL UNIT

For the realization of the control tasks in the experimental setup of the AC/DC converter the evaluation board PCA-2014 F2812 by Spectrum Digital® based on the TMS320F2811 Digital Signal Processor by Texas Instruments® has been chosen. Fig.2 presents the DSP-based control unit applied to the proposed laboratory setup of the PWM rectifier. The block diagram shows the signal processing routine. The TMS320F2812 DSP stems from the C28x family of TI® microprocessors and has been design to execute programs written in C/C++. This is the fixed-point, 32-bit data word microprocessor with two overlapping data and program address spaces. The major features of the presented DSP are: 18K words on-chip RAM, 128K words on-chip FLASH, 64K words off-chip SRAM, 30MHz clock (operating frequency up to 150MHz), 56 multiplexed digital Inputs/Outputs, 12-bit 16-channel Analog-to-Digital converter (80ns) with the input voltage range from 0 to 3V, 45 interrupts divided into 8 levels of priority, 5V of supplying voltage .Besides the DSP includes two Event

Man-ager systems for the applications to power electronics devices (PWM modulator to control three-phase two-level and three-level power converters. Before the TMS320F2812 DSP processes and executes a program it is required to configure manually all necessary registers and the ranges of the used memory since the microprocessor does not provide the ready-implemented CLS-type libraries. There is a large variety of the free environments helpful by configuring and programming the TMS microprocessors. The advanced programming environment for TI® microprocessors is Code Composer Studio™. There are also the coupling platforms for rapid prototyping and coding like Embedded Target for TI C2000 Toolbox™. The executable C code based on the Simulink™ graphical model is then generated automatically [3].

There are many consideration factors in the selection of a microprocessor in the design of a digital control system .After a thorough consideration of performance, price, simplicity in hardware design, and software support [1].



Fig. 2: PCA-2014 board based on TMS320F2811 DSP by Texas Instruments®

IV. DESIGN EXAMPLE

In this Section, a design example is presented for the following input/output specifications. To facilitate calculate in per unit, the following base quantities are defined.

$$\begin{aligned}
 P_{\text{base}} &= P_o = 1\text{KW} \\
 V_{\text{base}} &= V_{\text{dc}} = 30\text{V} \\
 I_{\text{base}} &= I_{\text{dc}} = 33.34\text{A} \\
 Z_{\text{base}} &= \frac{V_{\text{base}}}{I_{\text{base}}} = 0.89998 \Omega
 \end{aligned} \tag{1}$$

Input line voltage $V_{\text{in}}=13.8333 \text{ V}$ per unit

The phase-shifted full-Bridge output current I_o is given by

$$I_o = \frac{1}{N} * I_{\text{dc}} \tag{2}$$

Where N is the transformer turn ratio

Select $N=12:9, I_o=0.08337$ A per unit.

Neglecting losses, the utility line current can be expressed as

$$I_a = \frac{P_o}{\sqrt{3}} * V_i \quad (3)$$

The input current $I_a=0.050$ per unit.

A. Input filter design

high frequency current components in the input current of the phase shifted full bridge inverter can be filtered via a Capacitive C filter .The value of filter capacitor selected by following equation [5].

$$C_f = \frac{2 * P}{3 * v_m * W_i} \quad (4)$$

Where P is the power rating, V_m is the peak of input voltage, and W_i is angular input frequency.

B. Output filter design

Transformers and inductors both are magnetic components but there is difference in their functioning and design aspect. In a transformer, the core flux is decided by the magnetizing current .Where as in an inductor, the core flux is decided by the load current. Thus if the load current increases, there is possibility that the core may saturate and inductance will come down. So before decide the value of inductor maximum load current must be known and have the core which does not saturate at this current.

$$L = \frac{V_o * (1 - D)}{\Delta I * f_s} \quad (5)$$

$V_o = 30$ volt.

$D = 0.85$.

$\Delta I =$ Ripple current = 40% of output Current

$f_s =$ Switching frequency

V. SIMULATION RESULTS

In this section, simulation results of the proposed approach are discussed. Fig 3 shows High frequency output voltage V_{pri} of the phase-shifted full-Bridge inverter and input voltage V_{sec} of Synchronous rectifier. Fig 4 shows the output dc voltage (30V) at full load and maximum duty cycle. Fig 5 shows 3-phase input line voltage and Diode Bridge input current.

Table I: Design specification of proposed approach

No.	Parameter	Specification	Unit
1	P_o (Output Power)	1000	W
2	V_o (Output Voltage)	30	V
3	I_o (Output Current)	33.34	A
4	f_s (Switching Frequency)	18000	Hz
5	V_{in} (Input voltage)	415±15%	V
6	I_{in} (Input Current)	2	A

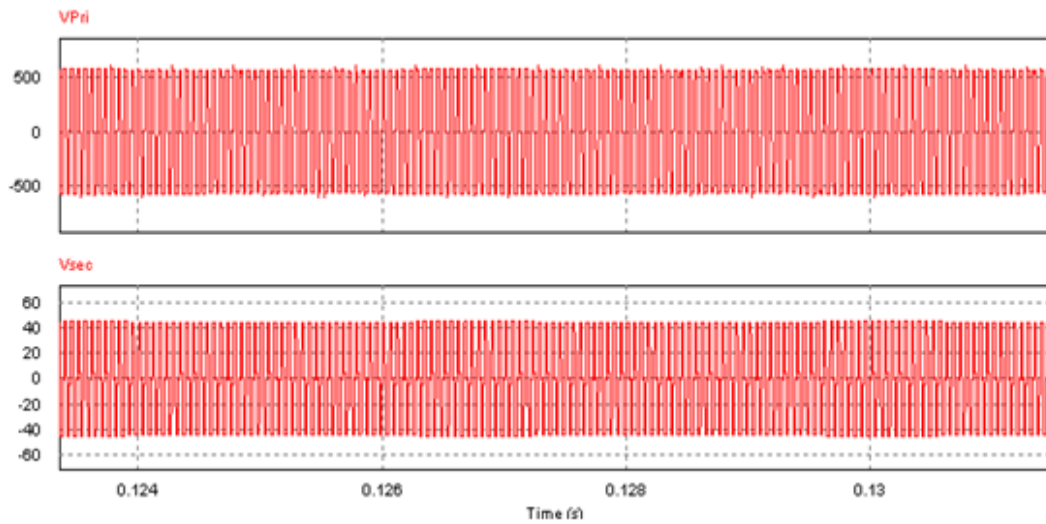

Fig. 3: High frequency output voltage V_{pri} of the phase-shifted full-Bridge inverter and input voltage V_{sec} of Synchronous rectifier.

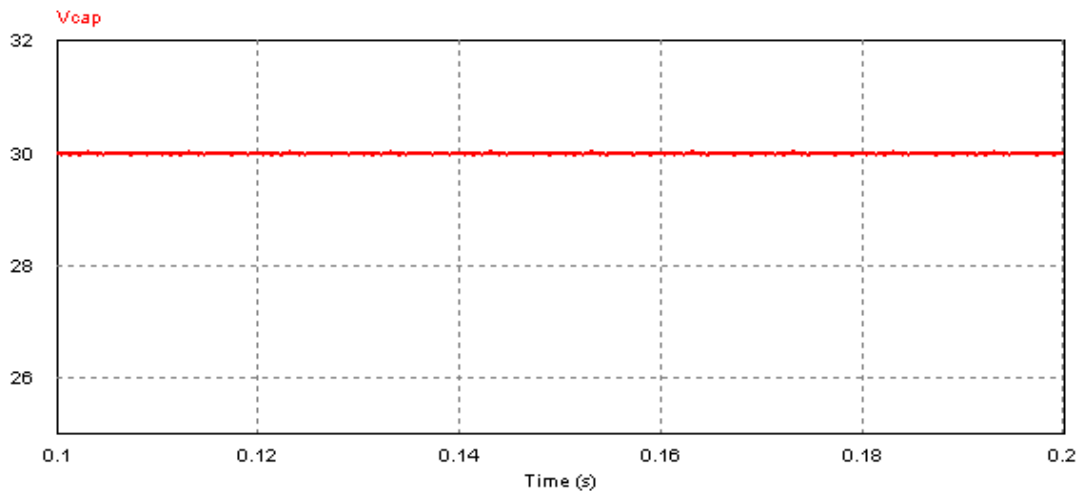
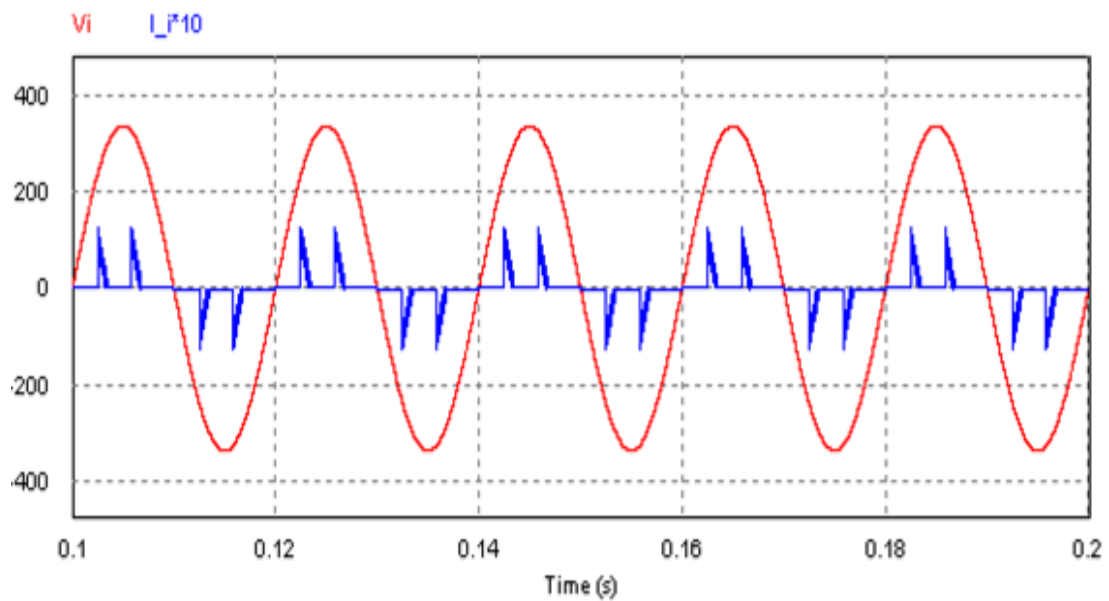

Fig. 4: output dc voltage (30V) at full load and maximum duty cycle



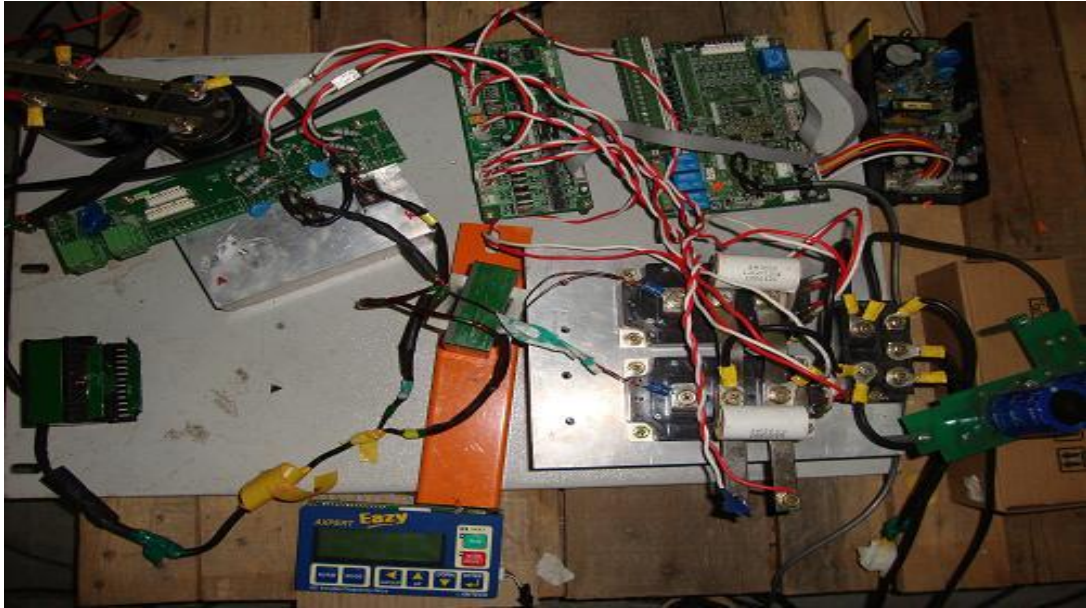

Fig. 6: Prototype of power supply based on synchronous rectification

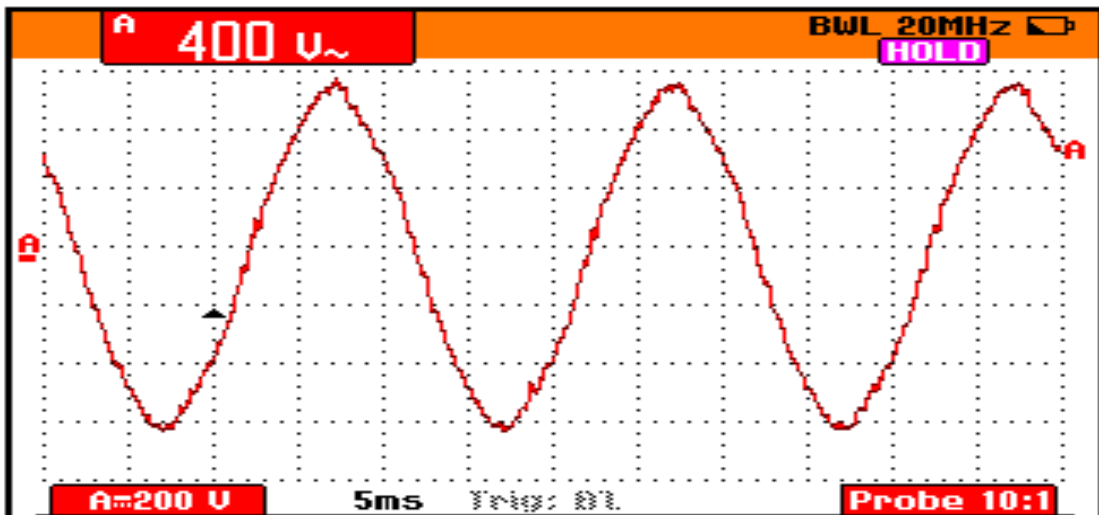

Fig. 7: 3-phase input power supply

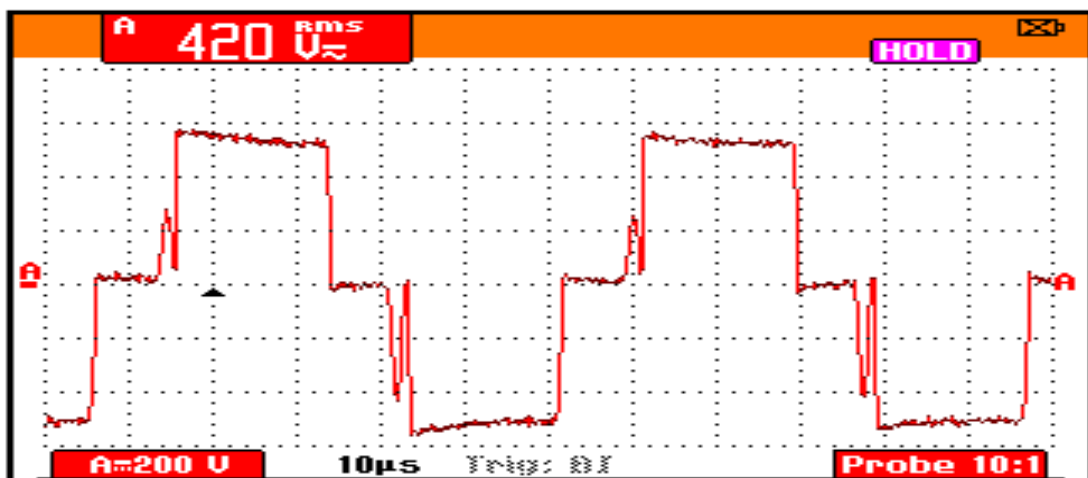

Fig. 8: Transformer primary voltage V_{pri} (200V per Division)

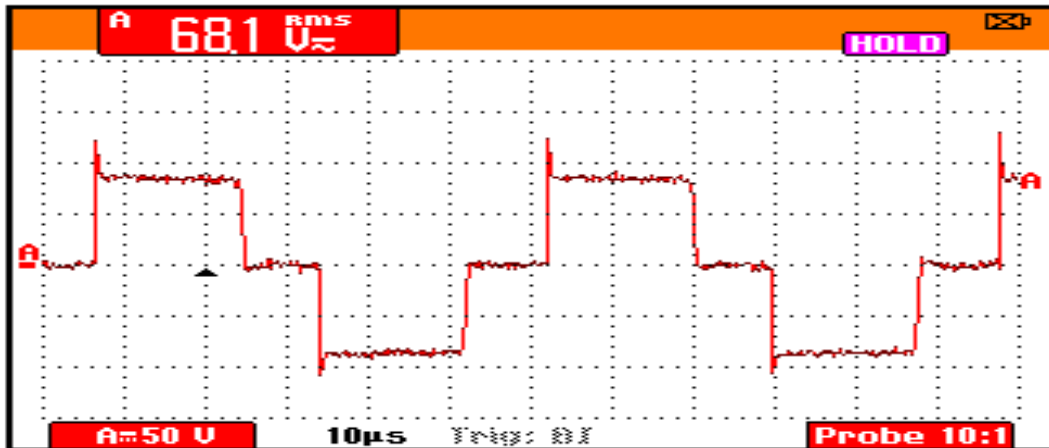

Fig. 9: Transformer secondary voltage V_{sec} (50V per Division)

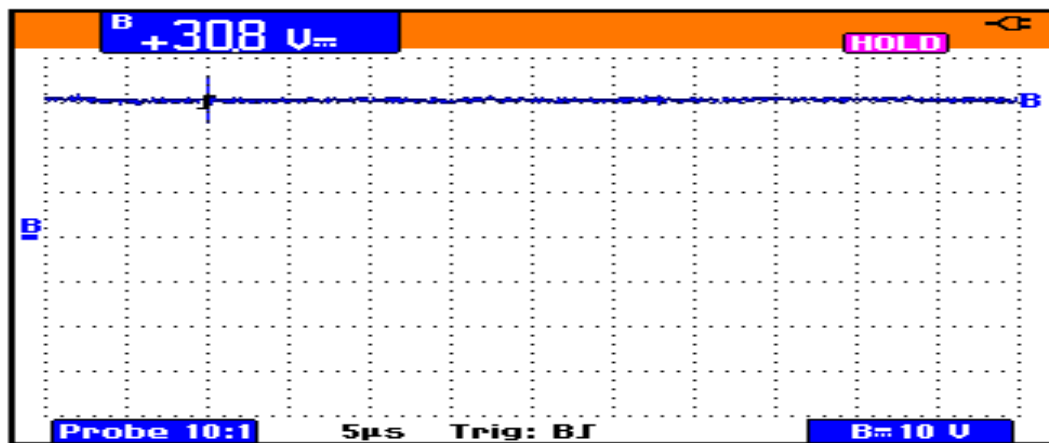

Fig. 10: Output dc voltage V_{dc}

VI. EXPERIMENTAL RESULTS

A laboratory prototype of the proposed DSP or digitally controlled power supply was constructed to meet the specifications detailed in section IV. A digital signal processor (TMS320F2011) was used for generating PWM gating signals and performing closed loop functions. Fig 1 shows the prototype of power supply based on synchronous rectification unit. The unit is connected to the LR filter and RC filter to produce power supply voltage of 30 V dc. Fig 8 shows Transformer primary voltage V_{pri} . Fig 9 shows Transformer secondary voltage V_{sec} . Fig 10 shows Output dc voltage V_{dc} .

VII. CONCLUSIONS

The proposed prototype of the PWM synchronous rectifier is based on the 1kW power module and the DSP-based control unit. For the proper operation the PWM rectifier requires the feedback information about all state variables. Hence the necessary voltage and current sensors have been constructed and examined. The supporting and protective electronic devices have been designed to enhance the safety of the AC/DC converter and its control system during the different conditions.

Voltage Oriented Control of the PWM rectifier has been implemented into the DSP-based control system. The advanced programming environment has facilitated coding in C language and provided the user-friendly interface between the host computer and the DSP evaluation board while executing the control programs. The simulation results have confirmed the proper approach to the design process showing the precious advantages of the synchronous rectifier AC/DC converter in the real applications.

ACKNOWLEDGMENT

It would be my proud privilege to tender the lexes of appreciation in respect of my honourable guide Prof. S.B. Bhatt, of B.H. Gardi College of Engineering and Technology for his erudite instruction, guidance, and support. It gives me immense contentment to accolade respected Prof. C.D. Parmar, HOD, Prof M.P.Patel PG Co-coordinator of the Department of Electronics & Communication Engineering of B.H.Gardi College of Engineering and Technology, Rajkot, Mr. Vinod patel of Amtech Electronics (I) LTD, Gandhinagar for their erudite instruction, guidance, and support.

REFERENCES

- [1]. Ying-Yu Tzou, Shih-Liang Jung: "Full Control of a PWM DC-AC converter for ac voltage Regulation," IEEE Transaction on Aerospace and Electronics System vol. 34, No.4 Oct. 1998.
- [2]. Ali Emadi, Alireza Khaligh, Zhong Nie, Young Joo Lee : "Integrated Power Electronic Converters and Digital Control" (chapter 11)
- [3]. Michal and Krzysztof : "Hardware Application of AC/DC Converter based on Intelligent Power Module and DSP Controller "prace naukowe instytutu maszyn, napędów i pomiarów elektrycznych politechniki wrocławskiej ,Nr 26 ,2006.
- [4]. Somnida Ratanapanachote, Han Ju Cha, and Prasad N. Enjeti : "A Digitally controlled switch Mode Power Supply Based on Matrix Converter" IEEE Transaction On Power Electronics, Vol. 21, No.1, Jan 2006.
- [5]. C.L. Neft and C.D. Schauder, "theory and design of 30hp matrix converter," IEEE transaction Ind. Appl., Vol. 28, No.3, PP. 546-551, May/Jun.1992.
- [6]. Wangfeng Zhang, Guang Feng, Yan-Fei Liu and Bin wu : " Adigital Power factor correction (PFC) Control strategy optimized for DSP," IEEE transaction on power electronics, Vol. 19, No. 6, Nov 2004