

Dynamic Modeling and Control of Grid Connected Hybrid Wind/PV Generation System

K. Shivarama Krishna¹, B. Murali Mohan², and Dr. M. Padma Lalitha³

¹PG Student, Dept of EEE, Annamacharya Institute of Technology & Sciences, Rajampet, Andhra Pradesh, India

²Assistant Professor, Dept of EEE, Annamacharya Institute of Technology & Sciences, Rajampet, India

³Professor & Head of the Department, Dept of EEE, Annamacharya Institute of Technology & Sciences.

E-Mail: iamshivaram@gmail.com

Abstract:- This paper presents a dynamic modeling and control strategy for a grid connected wind and PV hybrid system. The power extracted from hybrid wind-solar power system is transferred to the grid interface inverter by keeping common dc voltage as constant. A direct-driven permanent magnet synchronous wind generator is used with a variable speed control method whose strategy is to capture the maximum wind energy below the rated wind speed. This study considers both wind energy and solar irradiance changes in combination with load power variations. A 26-kW wind/solar hybrid power system dynamic model is explored. The examined dynamics shows that the proposed power system is a feasible option for a sustainable micro grid application.

Index Terms:- Grid-connected hybrid system, power conditioning system (PCS), variable speed wind turbine, PMSG, Photovoltaic (PV) array, PWM voltage source inverter, PI controller

I. INTRODUCTION

This paper presents a dynamic modeling and control of a grid-connected wind and PV hybrid system. Energy plays a major role in daily life. The degree of development and civilization of a country is measured by the amount of utilization of energy by human beings. Energy demand is increasing day by day due to increase in population, urbanization and industrialization. The fossil fuels are going to deplete in a few hundred years. The rate of energy consumption increasing and supply is depleting resulting in energy shortage. The depleting oil reserves, uncertainty and political issues concerning nuclear generation, and the environmental concerns associated with coal and natural gas-fired generation are encouraging researchers, practitioners and policy makers to look for alternative and sustainable sources of energy. Among them wind and solar generation have become predominant in recent years. These energy sources are preferred for being environmental-friendly. The Integration of these energy sources to form a hybrid system is an excellent option for distributed energy production.

Hybrid energy systems are inter-connected from wind power, photovoltaic power, fuel cell and micro turbine generator to generate power to local load and connecting to grid/micro grids. Because of the inherent nature of the solar energy and the wind energy, the electric power generations of the PV array and the wind turbine are complementary. The hybrid PV/wind power system has higher reliability to deliver continuous power than individual source. In order to draw the maximum power from PV arrays or wind turbines and to deliver the stable power to the load, a substantial battery bank is needed. However, the usage of battery is not an environmental friendly and there are some disadvantages like, heavy weights, bulky size, high costs, limited life cycles, and chemical pollution. Therefore one of the ways to utilize the electric energy produced by the PV array and the wind turbine systems is by directly connecting them to the grid.

II. PROPOSED SYSTEM CONFIGURATION

Fig. 1 presents the configuration of the hybrid power and its control system. The hybrid system consists of a wind turbine, a PV array, power electronic converters for conditioning the power associated with the hybrid energy sources, and a grid-interface inverter.

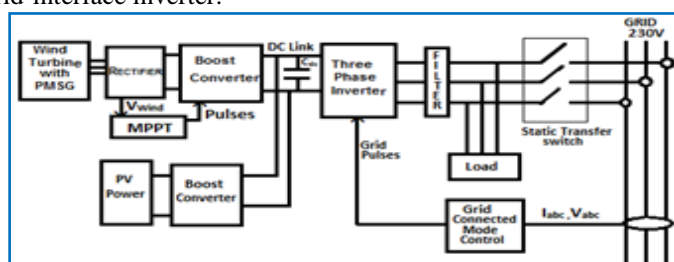

Fig.1 Configuration of the Proposed System

III. MODELING OF HYBRID SYSTEM

A. Wind Turbine Modeling

The wind turbine (WT) converts wind energy to mechanical energy by means of a torque applied to a drive train. A model of the WT is necessary to evaluate the torque and power production for a given wind speed and the effect of wind speed variations on the produced torque. The torque T and power produced by the WT within the interval $[V_{min}, V_{max}]$, where V_{min} is minimum wind speed and V_{max} is maximum wind speed, are functions of the WT blade radius R , air pressure, wind speed and coefficients C_p and C_q [1].

$$P_m = C_p(\lambda, \beta) \frac{\rho A}{2} V_{wind}^3 \quad (1)$$

C_p Is known as the power coefficient and characterizes the ability of the WT to extract energy from the wind.

C_q Is the torque coefficient and is related to according to:

$$C_q = \frac{C_p}{\lambda} \quad (2)$$

$$\lambda = \frac{R * \omega}{V_{wind}} \quad (3)$$

$$T = \frac{P_m}{\omega} \quad (4)$$

Where, C_p = Coefficient of performance,

P_m = Mechanical output power (watt), β = Blade pitch angle

ρ = Air density (kg/m^3), V_{wind} = Wind speed (m/s)

A = Turbine swept area(m^2), λ = Tip speed ratio

R = Radius of turbine blades (m), T = Torque of wind turbine, ω = Angular frequency of rotational turbine (rad/sec).

The performance coefficient $C_p(\lambda, \beta)$, which depends on tip speed ratio λ and blade pitch angle β , determines how much of the wind kinetic energy can be captured by the wind turbine system. A nonlinear model describes $C_p(\lambda, \beta)$ as:

$$C_p(\lambda, \beta) = C_1 \left(\frac{C_2}{\lambda_i} - C_3\beta + C_4 \right) e^{-C_5} + C_6 \quad (5)$$

B. Modeling of PMSG

The synchronous generator model is expressed in d-q rotating reference frame Park's model. The sinusoidal model assumes that the flux established by the permanent magnets in the stator is sinusoidal, which implies that the electromotive forces are sinusoidal. The generator is equipped with permanent magnets and has no damper winding. In order to simplify calculations the dynamic model of PMSG in the synchronous reference frame is transformed into d-q rotating reference frame using Park transformation [3].

$$V_{ds} = -R_s i_{ds} - L_d \frac{di_{ds}}{dt} + \omega L_q i_{qs} \quad (6)$$

$$V_{qs} = -R_s i_{qs} - L_q \frac{di_{qs}}{dt} + \omega L_d i_{ds} + \omega \phi_m \quad (7)$$

Where, V_{ds} = Direct axis voltage of PMSG

V_{qs} = Quadrature axis voltage PMSG

i_{ds} = Direct axis current of PMSG

i_{qs} = Quadrature axis current of PMSG

R_s = Stator resistance, ω = Angular frequency of rotor

L_d = Direct axis inductance

L_q = Quadrature axis inductance

ϕ_m = is the amplitude of the flux linkages established by the permanent Magnet

Electrical Torque T_e is given by

$$T_e = \frac{3}{2} (P) \phi_m i_{qs} \quad (8)$$

Where, P = Number of pole pairs of the PMSG.

Table I Parameters And Specifications Of Wind Turbine Model

PARAMETER NAME	VALUE	unit
Rated Power	20	kW
Rated wind speed	12	m/s
Rated Rotor speed	22.0958	rad/s
Blade Radius	2.7	m
Blade Pitch Angle	0	degree
Air Density	1.225	kg/m ³

The parameters of the investigated wind turbine model in this paper are shown in Table I. The aerodynamic torque is maximized at a given wind speed when the pitch angle of a blade(β) is 0 . Therefore, a constant pitch angle ($\beta =0$) is used in this study as shown in Table I.

C.PV System Model

The basic equation from the theory of semiconductors that mathematically describes the I-V characteristic of the ideal PV cells as follows.

$$I = I_{PV.cell} - \frac{I_{0.cell} \left[\exp\left(\frac{qV}{aKT}\right) - 1 \right]}{I_d} \quad (9)$$

$$I_d = I_{0.cell} \left\{ \exp\left[\frac{qV}{A} * k * T\right] - 1 \right\} \quad (10)$$

Where, I_d = diode current (amps)

$I_{PV.cell}$ = the current generated by incident light (amps)

$I_{0.cell}$ = is the reverse saturation of the diode (amps)

The basic Equation (10) of the elementary photovoltaic cell does not represent the I-V characteristic of a practical photovoltaic array. Practical arrays are composed of several connected photovoltaic cells and the observation of the characteristics at the terminals of the photovoltaic array requires the inclusion of additional parameters to the basic equation:

$$I = I_{pv} - I_0 \left[\exp\left(\frac{V + R_s I}{aV_t}\right) - 1 \right] - \frac{V + R_s I}{R_p} \quad (11)$$

Where, I_{pv} and I_0 are the photovoltaic and saturation currents of the array and $V_t = N_s kT/q$ is the thermal voltage of the array with N_s cells connected in series. Cells connected in parallel increase the current and cells connected in series increase the voltage. If the array is composed of N_{pp} parallel connections of cells the photovoltaic and saturation currents are expressed as: $I_{PV} = I_{PV.cell} N_{pp}$, $I_0 = I_{0.cell} N_{pp}$ and if the array is composed of N_{ss} series connections of cells the photovoltaic voltage is expressed as: $V = V_t * N_{ss}$. In eq. (11) R_s is the equivalent series resistance of the array and R_p is the equivalent parallel resistance. The light generated current of the photovoltaic cell depends linearly on the solar irradiation and is also influenced by the temperature according to the following equation.

$$I_{PV} = (I_{pv,n} + k_I \Delta T) \frac{G}{G_n} \quad (12)$$

Where, $I_{PV,n}$ is the light-generated current at the nominal condition (at STP 250 C and 1000 W/m²),

$\Delta T = T - T_n$ where, T is actual temperature and T_n is nominal temperatures in K, G is the irradiation on the device surface in W/m², and G_n is the nominal irradiation in W/m². The diode saturation current I_0 and its dependence on the temperature are expressed by:

$$I_0 = I_{0,n} \left(\frac{T_n}{T}\right)^3 \exp\left[\frac{qE_g}{ak} \left(\frac{1}{T_n} - \frac{1}{T}\right)\right] \quad (13)$$

$$I_{0,n} = \frac{I_{sc,n}}{\exp\left(\frac{V_{oc,n}}{aV_{t,n}}\right) - 1} \quad (14)$$

The $V_{t,n}$ is thermal voltage of N_s series connected cells at the nominal temperature T_n . The photovoltaic model described in the previous section can be improved if eq.(13) is replaced by

$$I_0 = \frac{I_{sc,n} + K_I \Delta T}{\exp\left(\frac{V_{oc,n} + K_V \Delta T}{a V_t}\right) - 1} \quad (15)$$

This modification aims to match the open circuit voltages of the model with the experimental data for a very large range of temperatures. The eq.(15) is obtained from eq.(14) by including the current and voltage coefficients K_V and K_I .

D. MATLAB/Simulink Modeling of PV Array

A typical KC-200GT PV module is considered . The module has 54 cells in series. For desired output voltage and current, the proposed solar PV power generation system (6kW) consists of 30 PV modules with 10x3 series-parallel arrangements. Each module can produce 200W of DC electric power. Typical electrical characteristics of a KC-200GT PV module are shown in Table II at solar radiation of 1000W/m² and cell temperature of 25°C (STC).

Table II Parameters Of A Kc-200gt Solar Array Under Stc*

PARAMETER NAME	RATING
Maximum Power (P_{max})	200W (+10% / -5%)
Maximum Power voltage (V_{mpp})	26.3V
Maximum power current (I_{mpp})	7.61A
Open circuit voltage (V_{oc})	32.9V
Short circuit current (I_{sc})	8.21A
Voltage / Temperature coefficient	-0.1230 V/K
Current/ Temperature coefficient	0.0032 A/K
Series Connected cells (N_s)	54

E. Model of Grid Connected WIND/PV Hybrid System

The hybrid energy system is a photovoltaic array coupled with a wind turbine which is shown in Figure-2.

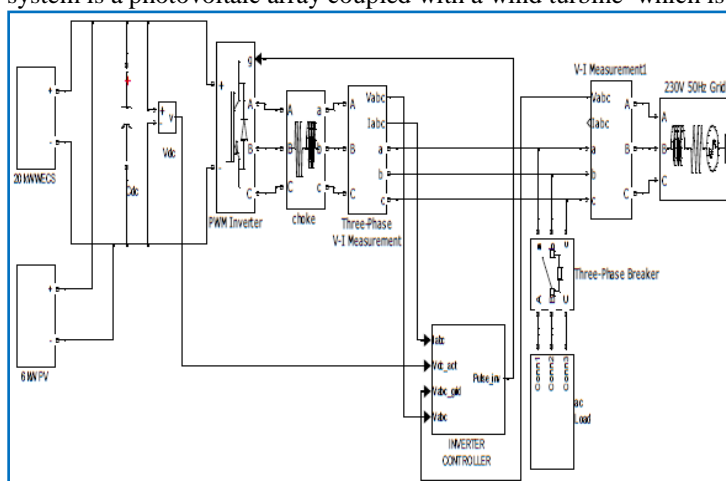

Fig.2 MATLAB/Simulink diagram of Grid connected wind /PV hybrid system

IV. CONTROL STRATEGIES

A. Power conditioning system

Renewable Energy Sources (RES's) will generate energy in the form of DC/AC with different voltage and frequency levels. Power electronic interface is to inter-connect RES with grid. The photovoltaic system will give us unregulated DC output voltage due to change in input parameters like irradiation and temperature. By using boost converter we can control the output of PV system. The regulated DC output which is connected to the grid through VSI.

AC output is generated from wind turbine generator. The output of generator is converted to DC by using uncontrolled rectifier. The boost converter is used to control the DC link voltage due to change in wind speed. Then the regulated DC output is inter-connected to the grid through VSI. The VSI is controlled by PQ-controller.

In hybrid wind and PV energy system, the rectified wind energy and the output of PV system is connected to the boost converter to regulate DC link voltage. The regulated DC supply is connected to the grid through DC link and VSI. The VSI is controlled by PQ-controller. The power conditioning system for hybrid energy systems includes DC/DC boost converter, Inverter, PQ-control and RL filter.

B. Modeling and control of grid side converter

Since the machine is grid connected the grid voltage as well as the stator voltage is same, there exists a relation between the grid voltage and DC link voltage. The main objective of the grid side converter is to maintain DC link voltage constant for the necessary action. The voltage oriented vector control method is approached to solve this problem.

The detail mathematical modeling of grid side converter is given below. The control strategies are made following the mathematical modeling and it is shown in Fig.3. The PWM converter is current regulated with the direct axis current is used to regulate the DC link voltage whereas the quadrature axis current component is used to regulate the reactive power. The reactive power demand is set to zero to ensure the unit power factor operation [9].

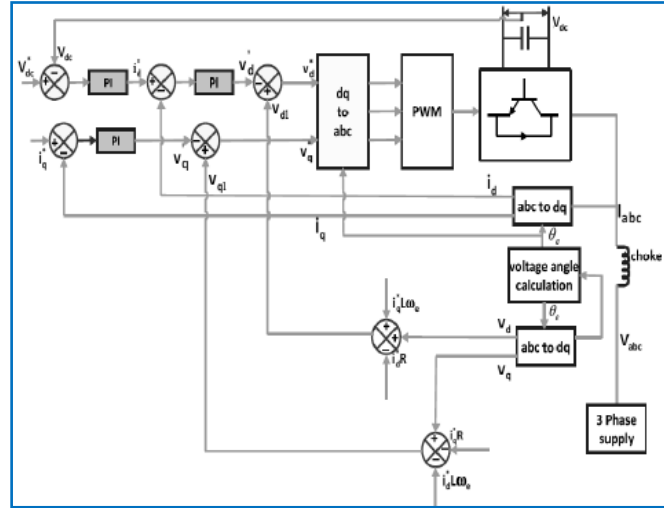

Fig.3 Control block diagram of grid side converter

The voltage balance across the line is given by eq.(16), where R and L are the line resistance and reactance respectively. With the use of d-q theory the three phase quantities are transferred to the two phase quantities.

$$\begin{bmatrix} V_a \\ V_b \\ V_c \end{bmatrix} = R \begin{bmatrix} I_a \\ I_b \\ I_c \end{bmatrix} + L \frac{d}{dt} \begin{bmatrix} I_a \\ I_b \\ I_c \end{bmatrix} + \begin{bmatrix} V_a' \\ V_b' \\ V_c' \end{bmatrix} \quad (16)$$

For the grid side converter the mathematical modeling can be represented as

$$V_d = Ri_d + L \frac{di_d}{dt} - \omega_e Li_q + V_{di} \quad (17)$$

$$V_q = Ri_q + L \frac{di_q}{dt} - \omega_e Li_d + V_{qi} \quad (18)$$

Where V_{di} and V_{qi} are the two phase voltages found from V_a', V_b', V_c' using d-q theory.

V. RESULTS AND DISCUSSIONS

Model of wind turbine coupled with PMSG and model of Photovoltaic energy system are interconnected with grid through full scale power electronic devices by using MATLAB/Simulink. The performance study is done for the simulated system under input variations at RES's and load variations.

A. Case-I: Constant Generation & Constant Load

In this case the inputs like irradiation, temperature, and wind speed are kept constant with a constant ac load near Grid are considered for simulation. The irradiation 900 W/m², temperature 25°C, for PV and wind speed of 8 m/s are given as inputs to the simulated Hybrid model and load parameters as 7.5 kW active power, 5.0404 kVAR Inductive reactive power connected to 230 V, 50 Hz Grid. The system is simulated for 1 second and load is connected through a breaker which closes at 0.5 second. The results are as follows:

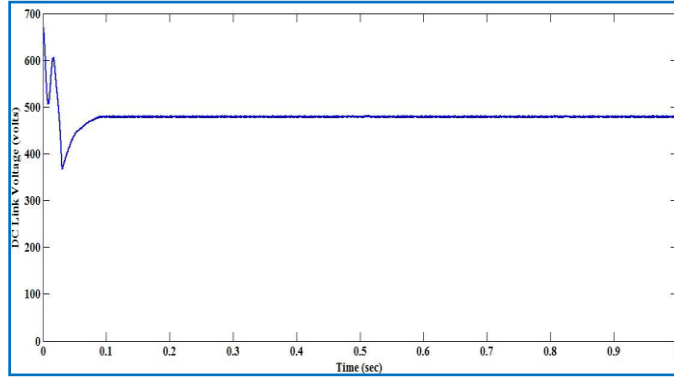

DC Link Voltage case I

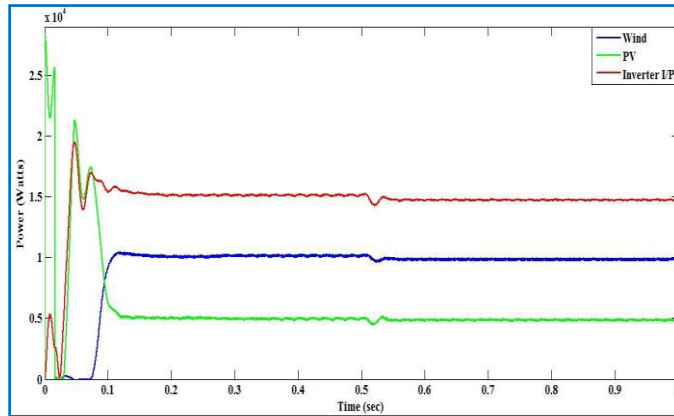

Power of Hybrid System case I

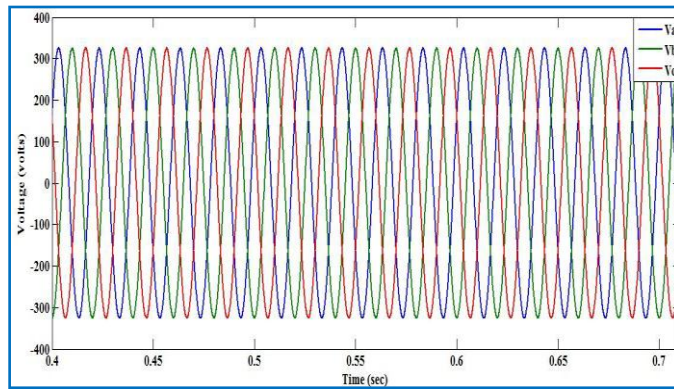

Inverter Output Voltage case I

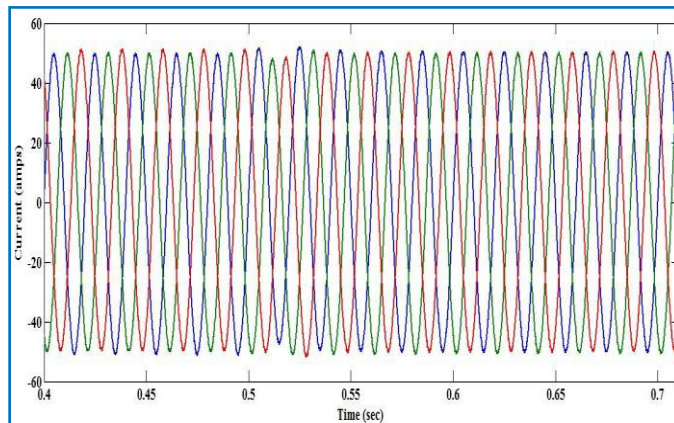

Inverter Output Current case I.

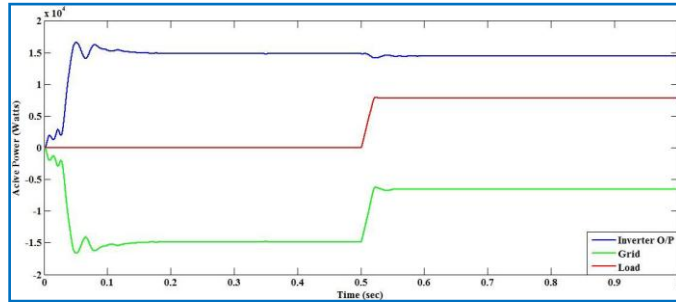

Active Power distribution case I

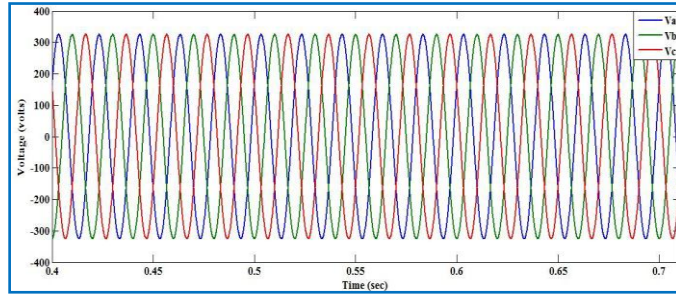

Grid Voltage case I

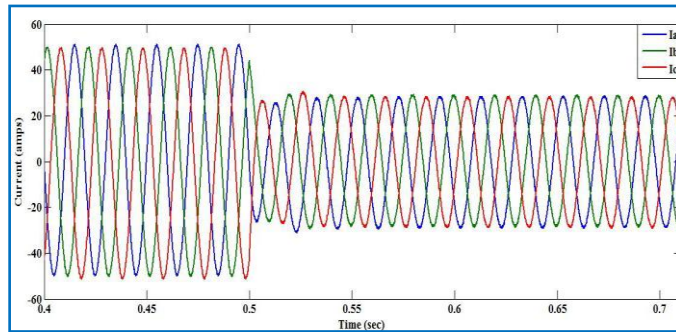

Grid Current case I

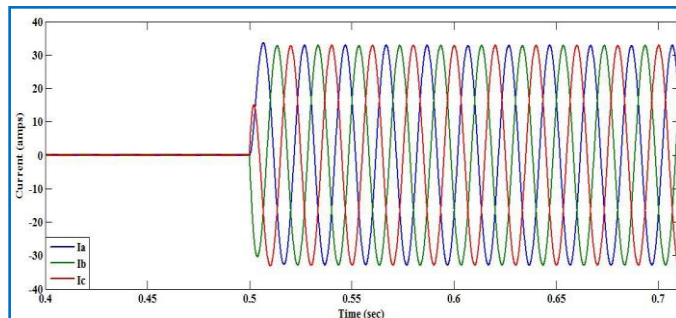

Load Current case I

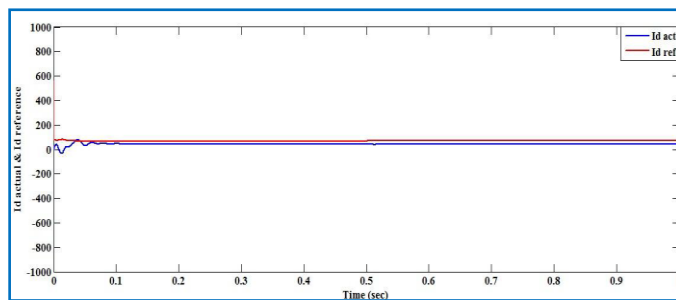

Id actual tracking Idref reference case I

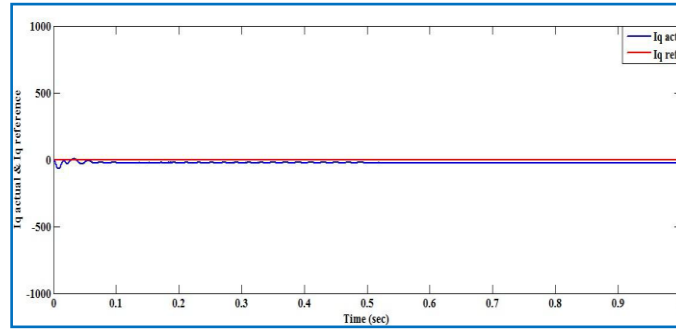

Iq actual tracking Iqref reference case I

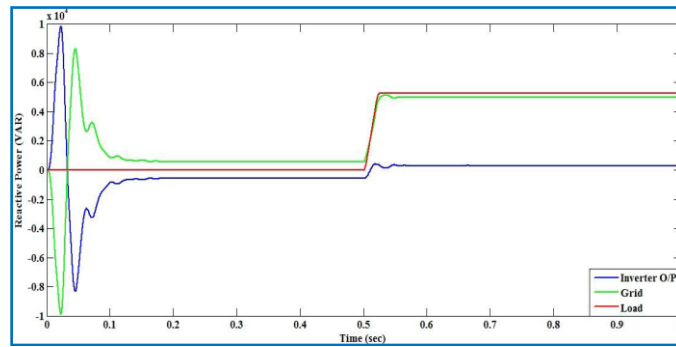

Reactive Power Distribution case I

Observations:

Case-I: In this case both Hybrid Wind and PV generation as well as ac load is constant. Load of 7.5 kW active power, 5.0404 kVAR is connected to ac grid at 0.5 second by a breaker. The Power required by the Load is supplied by the Hybrid system and remaining power is fed in to the Grid. So Hybrid Wind and PV active power generation remains constant, wind reactive power is maintained at zero as controller has restricted the Hybrid model to generate it and at common point of coupling inverter, grid and load voltage remains at Peak voltage 325.26 V, 50Hz.

B. Case-II: Constant Generation & Change in Load

In this case the inputs like irradiation, temperature, and wind speed are kept constant with a change in ac load near Grid are considered for simulation. The irradiation 900 W/m², temperature 25°C, for PV and wind speed of 8 m/s is given as inputs to the simulated Hybrid model. Change in Load is illustrated by connecting a Load of 7.5 kW active power, 5.0404 kVAR Inductive reactive power at 0.4 second by breaker 1 and another Load of 4 kW active power, 3.3143 kVAR connected through breaker 2 at 0.7 second. So from 0.4 second to 0.7 second the Load will be 7.5 kW, 5.0404 kVAR and from 0.7 second to 1 second the Load will be 11.5 kW, 8.3547 kVAR. These local ac loads are connected to 230 V, 50 Hz Grid. The system is simulated for 1 second and the loads are connected through a breaker which closes at 0.4 second and 0.7 second. The results are as follows:

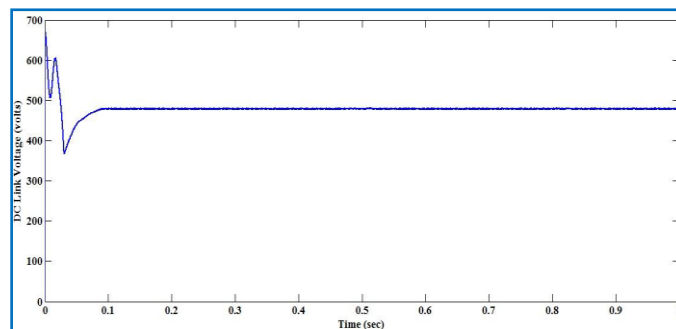

DC Link Voltage case II

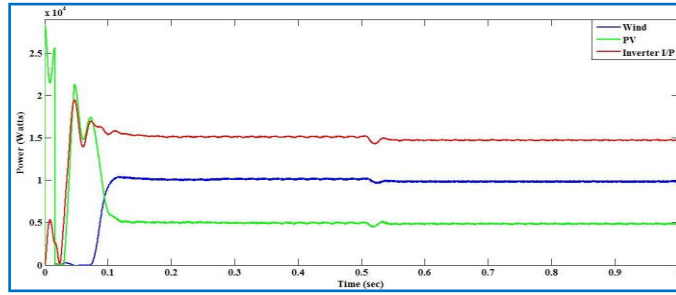

Power of Hybrid System case II

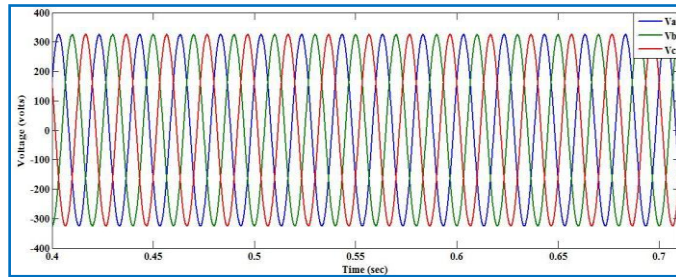

Inverter Output Voltage case II

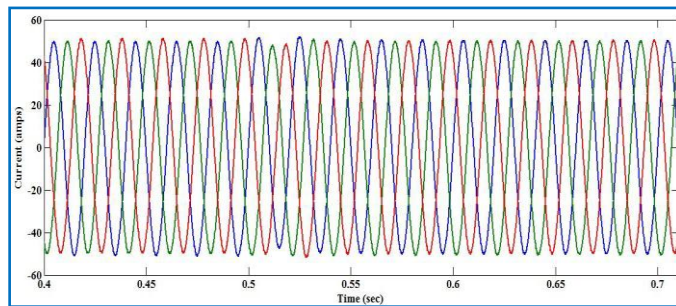

Inverter Output Current case II

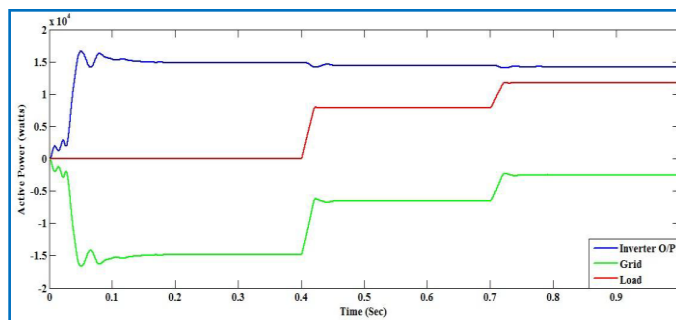

Active Power Distribution case II

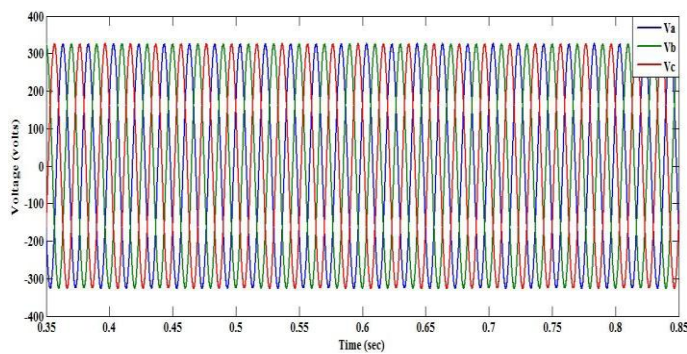

Grid Voltage case II

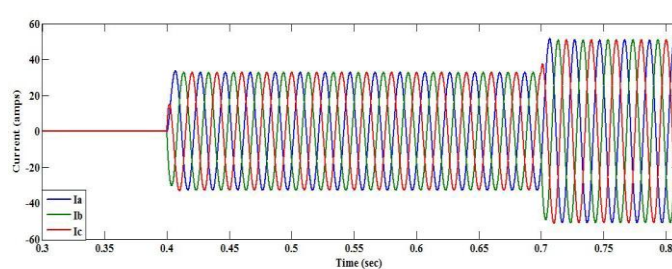

Load Current case II

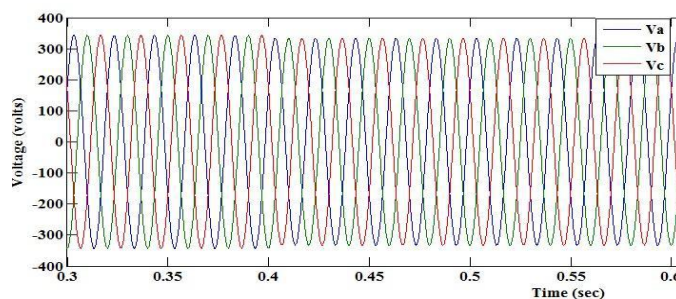

Load Voltage case II

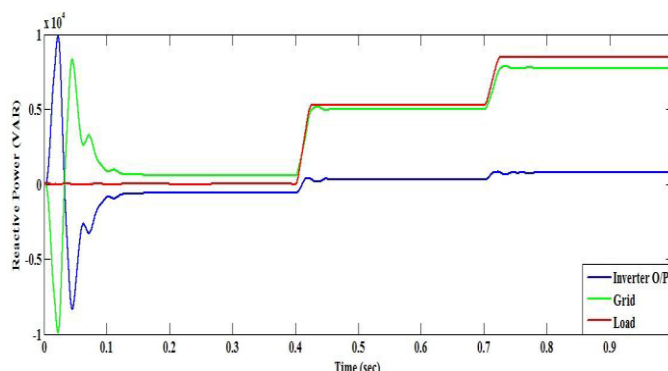

Reactive Power Distribution case II

Observations

Case-II: In this case Hybrid Wind and PV generation is constant. Change in Load is achieved by using Breakers for connecting Loads. Load of 7.5 kW active power, 5.0404 kVAR is connected to ac grid at 0.4 second by closing breaker 1. At 0.7 second breaker 2 is closed to connect a Load of 4 kW active power, 3.3143 kVAR. The Power required by the Load is supplied by the Hybrid system and remaining power is fed in to the Grid. So from 0.4 second to 0.7 second the Load will be 7.5 kW, 5.0404 kVAR and from 0.7 second to 1 second the Load will be 11.5 kW, 8.3547 kVAR. So Hybrid Wind/PV active power generation remains constant, wind reactive power is maintained at zero as controller has restricted the Hybrid model to generate it and at common point of coupling inverter, grid and load voltage remains at Peak voltage 325.26 V, 50Hz.

C. Case-III: Variable Generation & Change in Load

In this case both the inputs parameters like irradiation and wind speed are varied with a change in ac load near Grid are considered for simulation. Change in Generation is achieved by changing the irradiation of PV system and Wind speed of WECS. In our simulation we consider a change of irradiance from 900 W/m² to 600 W/m² at 0.5 second, Similarly for WECS the change in speed from 6m/s to 8m/s at 0.5 second. Change in Load is illustrated by connecting a Load 1 of 7.5 kW active power, 5.0404 kVAR Inductive reactive power at 0.4 second, here the breaker 1 closes and at 0.8 second the breaker is opened. Load 2 of 4 kW active power, 3.3143 kVAR connected through breaker 2 at 0.6 second. So from 0.4 second to 0.6 second the Load will be 7.5 kW, 5.0404 kVAR; from 0.6 second to 0.8 second the Load will be 11.5 kW, 8.3547 kVAR and from 0.8 second to 1 second the Load will be 4 kW active power, 3.3143 kVAR. These local ac loads are connected to 230 V, 50 Hz Grid. The system is simulated for 1 second. The results are as follows:

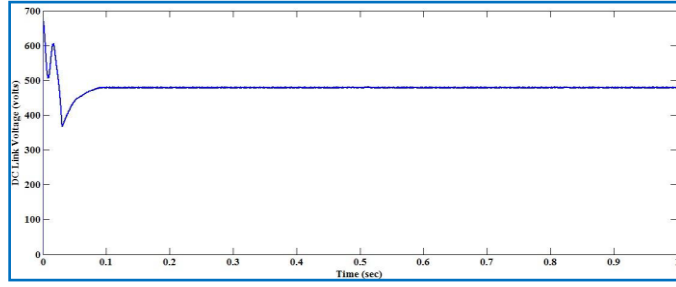

DC Link Voltage case III

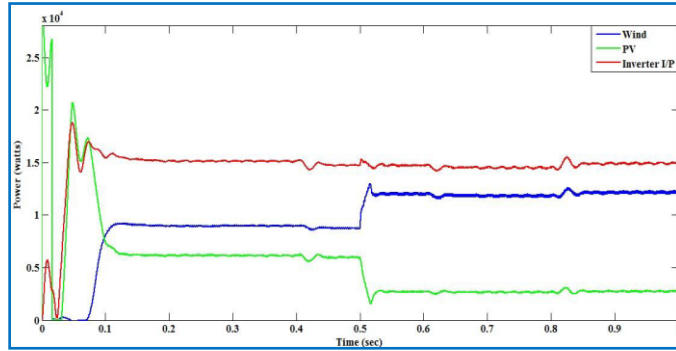

Power of Hybrid System case III

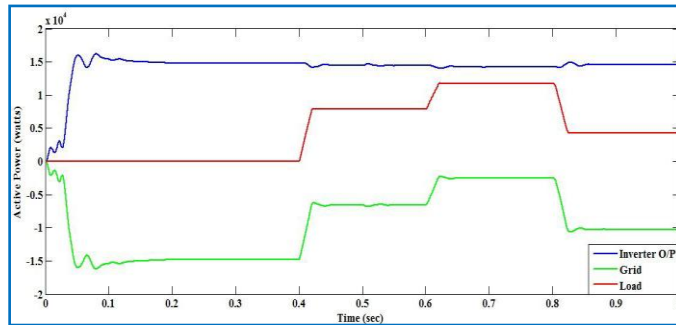

Active Power Distribution case III

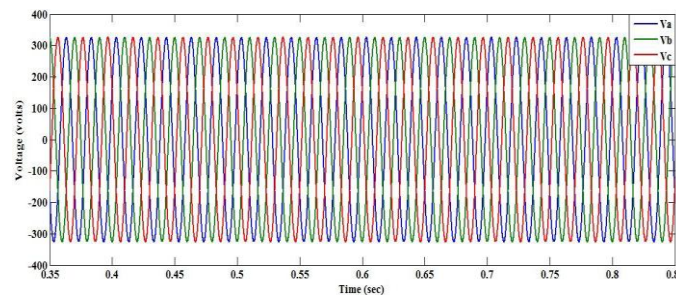

Grid Voltage case III

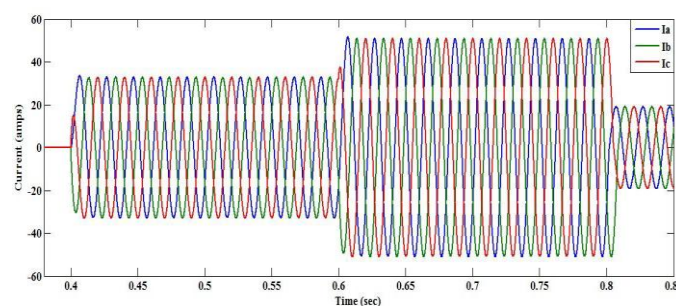

Load current case III

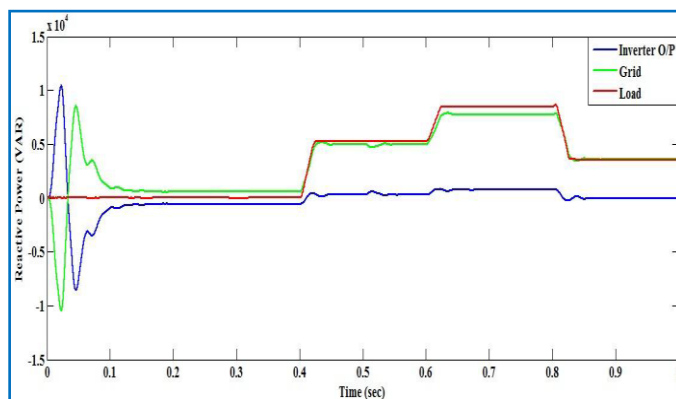

Reactive Power distribution case III

Observations

Case-III: In this case Hybrid Wind/PV generation the input parameters are varied, irradiance of PV is changed from 900 W/m² to 600 W/m² at 0.5 second, Similarly for WECS the change in speed from 6m/s to 8m/s at 0.5 second. Change in Load is achieved by using 2 Breakers for connecting Loads. The Power required by the Load is supplied by the Hybrid system and remaining power is fed in to the Grid.

VI. CONCLUSION

The modeling of hybrid Wind and PV for power system configuration is done in MATLAB/SIMULINK environment. The present work mainly includes the grid tied mode of operation of hybrid system. The models are developed for all the converters to maintain stable system under various loads and resource conditions and also the control mechanism are studied. The dynamic performance of Hybrid Wind and Photovoltaic power systems are studied for different system disturbances like load variation, wind speed variation and different irradiation and temperature inputs.

The simulation results shows that, using a VSI and PQ control strategies, it is possible to have a good response of grid-connected hybrid energy system. The hybrid grid can provide a reliable, high quality and more efficient power to consumer. The hybrid grid may be feasible for small isolated industrial plants with both PV systems and wind turbine generator as the major power supply.

REFERENCES

- [1]. Jitendra Kasera, Ankit Chaplot and Jai Kumar Maherchandani,(2012). "Modeling and Simulation of Wind-PV Hybrid Power System using Matlab/Simulink", IEEE Students' Conference on Electrical, Electronics and Computer Science.
- [2]. K. T. Tan, P. L. So, Y. C. Chu, and K. H. Kwan, (2010). "Modeling, Control and Simulation of a Photovoltaic Power System for Grid-connected and Standalone Applications", IEEE- IPEC.
- [3]. Alejandro Rolan, Alvaro Luna, Gerardo Vazquez and Gustavo Azevedo, (2009). "Modeling of a Variable Speed Wind Turbine with a Permanent Magnet Synchronous Generator", IEEE International Symposium on Industrial Electronics.
- [4]. D. Kastha, S. N. Bhadra, S. Banerjee, "Wind Electrical Systems," Oxford University Press, New Delhi, 2009.
- [5]. B. M Hasaneen and Adel A. Elbaset Mohammed, (2008). "Design and Simulation of DC/DC Boost Converter", IEEE.
- [6]. Chen Wang, Liming Wang, Libao Shi and Yixin Ni, (2007). "A Survey on Wind Power Technologies in Power Systems", IEEE.
- [7]. Fei Ding, Peng Li, Bibin Huang, Fei Gao, Chengdi Ding and Chengshan Wang, (2010). "Modeling and Simulation of Grid-connected Hybrid Photovoltaic/Battery Distributed Generation System", China International Conference on Electricity Distribution.
- [8]. Frede Blaabjerg and Zhe Chen, (2006). "Power Electronics for Modern Wind Turbines", A Publication in the Morgan & Claypool Publishers' Series. IEEE 1547 (2008). "IEEE Standard for Interconnecting Distributed Resources with Electric Power Systems". IEEE Standards Coordinating Committee 21 on Fuel Cells, Photovoltaics, Dispersed Generation, and Energy Storage.
- [9]. R. Pena, J. C. Clare, G. M. Asher, "Doubly fed induction generator using back to back PWM converters and its application to variable speedwind energy generation," in Proc. IEE Electr. Power Appl. may 1996.