

# Implementation of Texture Feature Based Medical Image Retrieval Using 2-Level Dwt and Harris Detector

Ch.Sravani<sup>1</sup>, D. Hari Krishna<sup>2</sup>, M.C.Chinnaiah<sup>3</sup>

<sup>1</sup>M.Tech. Student, Padmasri Dr.B.V.Raju Institute of Technology, Narsapur

<sup>2</sup>Senior Assistant Professor, Padmasri Dr.B.V.Raju Institute of Technology, Narsapur

<sup>3</sup>Associate Professor, Padmasri Dr.B.V.Raju Institute of Technology, Narsapur

---

**Abstract:**—Content based image retrieval using 2-level discrete wavelet transform (DWT) has been proposed, to retrieve the medical images from the database according to their similarity to the Query image. This permits radiologists to retrieve images of same features that leads to similar diagnosis as the input image. This is different from other fields of Content Based Image Retrieval (CBIR) where the same category images will match a part of an image. We cannot apply such techniques to medical images. In this paper we follow two steps. Firstly, we calculate the 2-level DWT of all images in database. Secondly, to calculate the energy and then Euclidean distance between query and database images to perfectly match the query image with database images for proper diagnosis. We find the algorithm with Harris Detector is most effective when used to perform appropriate search.

**Keywords:**—Retrieving Images, CBIR (Content Based Image Retrieval) system, Euclidean distance and energy, Harris detector.

---

## I. INTRODUCTION

Content-Based Image Retrieval (CBIR) is the process of retrieving images from a database on the basis of features that are extracted automatically from the images themselves [2]. A CBIR method typically converts an image into a feature vector representation and matches with the images in the database to find out the most similar images. In the last few years, several research groups have been investigating content based image retrieval i.e, Text-based image retrieval can be traced back to the 1970's; images were represented by textual descriptions and subsequently retrieved using a text-based database management system [3]. Content-based image retrieval utilizes representations of features that are automatically extracted from the images themselves. Most of the current CBIR systems allow for querying-by-example, a technique wherein an image (or part of an image) is selected by the user as the query. Much of the research effort related to images is undertaken in the medical physics area. The medical and related health profession use and store visual information in the form of X-rays, ultrasound or other scanned images, for diagnosis and monitoring purposes.

The system extracts the features of the query image searches through the database for images with similar features, and displays relevant images to the user in order of similarity to the query [6][7][8][9]. The paper is organized as follows. Block diagram of proposed method is presented in Section II. Section III describes the 2-level DWT. Section IV gives brief introduction of Harris detector for detecting the corners. The texture feature calculation is presented in Section V. Euclidean Distance calculations are made in Section VI. The measurement analysis is presented in Section VII. Results are shown in section VIII. Section IX describes the conclusion.

## II. BLOCK DIAGRAM OF PROPOSED ALGORITHM

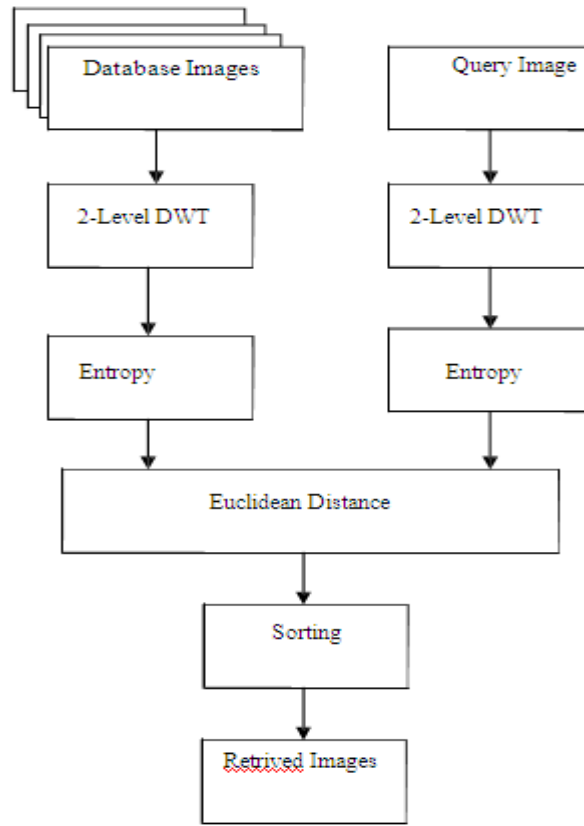

Fig1. Block Diagram of algorithm

The procedure of block diagram as shown below

- 1) Input as Query image is taken.
- 2) Apply 2-level DWT to the Query Image.
- 3) Calculate the Entropy of Query image.
- 4) Calculate the Euclidean Distance of query.
- 5) Repeat the steps 1 to 4 for Database images.
- 6) Similarity comparison is done with the query Image and Database Images
- 7) Sorting of the Database images is done according with the distance calculations.
- 8) Finally relevant images are retrieved with respect to corresponding query image.
- 9) Repeat step 1 to 8 for another query image.

## III. 2-LEVEL DWT

2-level DWT is also called pyramid structural wavelet. The wavelet transform transforms the image into a multi-scale representation with both spatial and frequency characteristics. This allows for effective multi-scale image analysis with lower computational cost. Using the DWT, the texture image is decomposed into four sub images, as low-low, low-high, high-low and high-high sub-bands. The energy level of each sub-band is calculated. This is first level decomposition. Using the low-low sub-band for further decomposition is done. So, total sub bands in 2-level DWT is 7. Image quality is better at low-low sub band compare to other sub bands as shown in fig .2. After that calculate energy of each sub band are explained in section V.

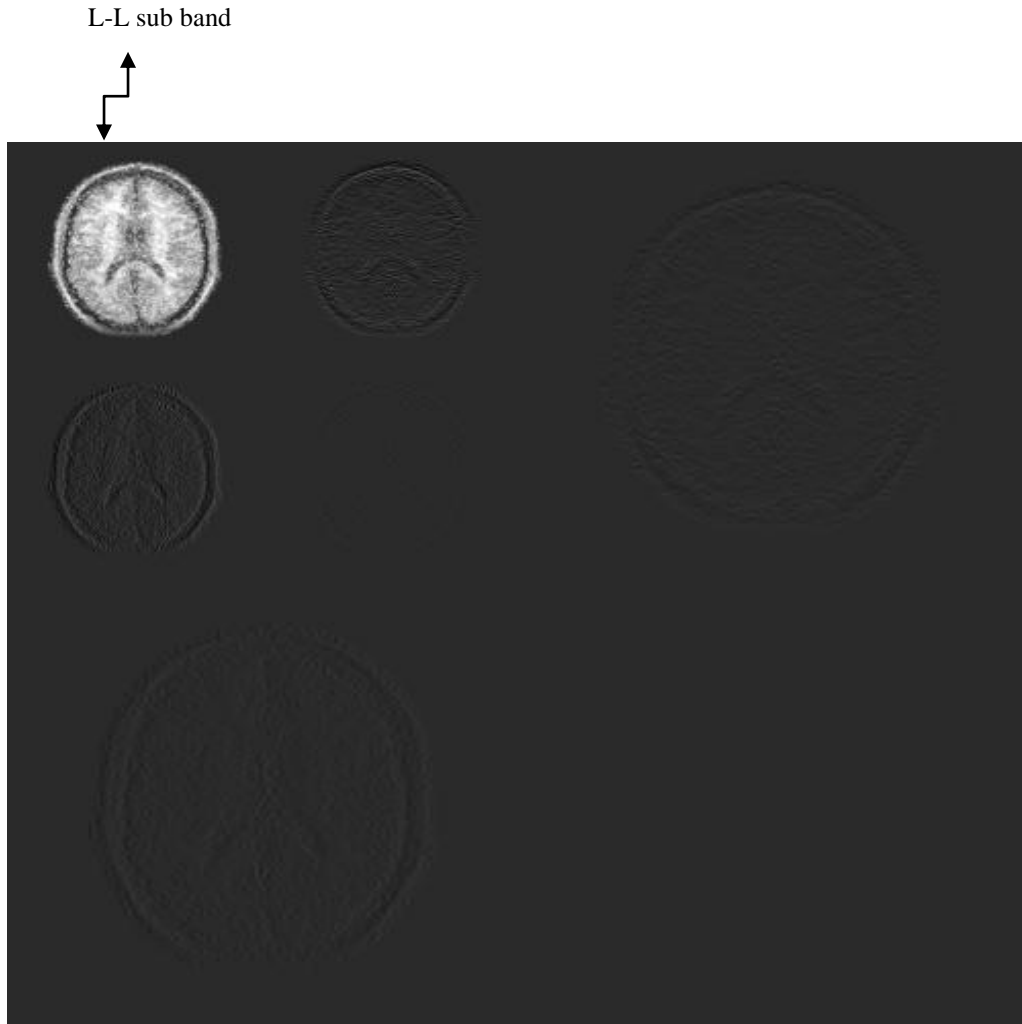

In this work, Haar is the simplest and most widely used, while Daubechies have fractal structures and are vital for current wavelet applications. So Haar wavelets are used here. The Haar wavelet's mother wavelet function  $\psi(t)$  can be described as

$$\psi(t) = \begin{cases} 1 & 0 \leq t < 1/2, \\ -1 & 1/2 \leq t < 1, \\ 0 & \text{otherwise.} \end{cases}$$

Its scaling function  $\phi(t)$  can be described as

$$\phi(t) = \begin{cases} 1 & 0 \leq t < 1, \\ 0 & \text{otherwise.} \end{cases}$$

#### IV. HARRIS CORNER DETECTOR

Harris corner detector is used to detect the corners in digital images. This detector find the interest point of corner of object in an image as shown in fig 3. The majority of corner detectors fall into this interest point category. This is in contrast to corner detectors which find corners by tracing the contours of objects and look for local maxima of absolute curvature or approaches using morphological operators. It detects only a small number of isolated points. These points are reasonably invariant to rotation, small changes of scale and small affine transformations. This is used for matching, finding correspondence and tracking.

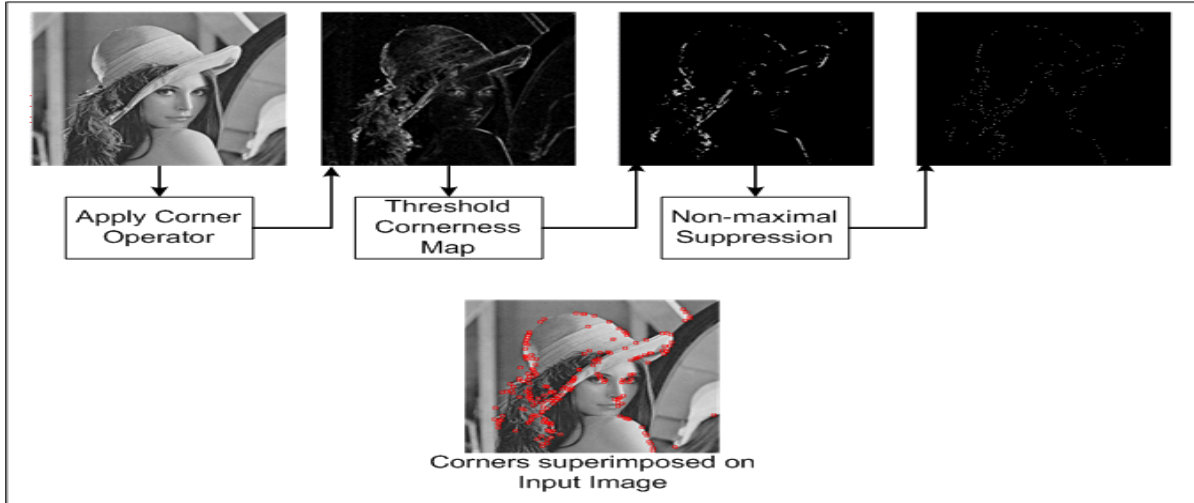

Fig.3. Find the interest of corners using Harris detector.

The procedure for Harris corner detector as shown below

1. For each pixel  $(x, y)$  in the image calculate the autocorrelation matrix  $M$ :

$$M = \begin{pmatrix} A & C \\ C & B \end{pmatrix}$$

$$A = \left( \frac{dI}{dx} \right)^2 \otimes w \quad B = \left( \frac{dI}{dy} \right)^2 \otimes w \quad C = \left( \frac{dI}{dy} \frac{dI}{dx} \right)^2 \otimes w$$

$\otimes$  is the convolution operator

$w$  is the Gaussian window

2. Construct the cornerness map by calculating the cornerness measure  $C(x, y)$  for each pixel  $(x, y)$ :

$$\begin{aligned} C(x,y) &= \det(M) - k(\text{trace}(M))^2 \\ \det(M) &= \lambda_1 \lambda_2 = AB - C^2 \\ \text{trace}(M) &= \lambda_1 + \lambda_2 = A + B \\ k &= \text{constant} \end{aligned}$$

3. Threshold the interest map by setting all  $C(x, y)$  below a threshold  $T$  to zero.
  4. Perform non-maximal suppression to find local maxima.
- All non-zero points remaining in the cornerness map are corners.

## V. ENERGY OR ENTROPHY CALCULATION

A 2-level DWT with depth  $L$  typically yields  $J=4(3*L+1)$  sub-images. The normalized energy was computed on each sub-image and defined as

$$E = \frac{1}{N} \sum_{ij} X_{ij}^2$$

The wavelet energy features reflect the distribution of energy along the frequency axis over scale and orientation and have proven to be very powerful for texture characterization. Since most relevant texture information has been removed by iteratively low pass filtering, the energy of the low resolution sub-images are generally not considered as texture features. An alternative feature for a texture is the entropy

$$Et = \frac{1}{N} \sum_{ij} X_{ij}^2 \log(X_{ij}^2)$$

Note that since both energy and entropy are measures of the dispersion of the wavelet coefficients, they are strongly correlated. And some experimental results showed that the performance of the energy feature was statistically the same as or better than the entropy feature alone and combination of the energy and entropy features.

### VI. EUCLIDEAN DISTANCE

Euclidean distance is the distance between energy of images from database and energy of query image. The formula of Euclidean distance is given by

$$d = \text{sum}((\text{query}-\text{dbimage}).^2).^0.5$$

Here Query is the energy of query image and dbimage is the energy of database images.

### VII. MEASUREMENT ANALYSIS

In this paper, two types of performance measurement are used.

a) Precision =  $\text{Number of relevant images retrieved} / \text{total number of images retrieved}$

As shown figures in result section, the average precision rate is 100%

b) Recall =  $\text{Number of relevant images retrieved} / \text{total number of relevant images in database}$ .

As shown figures in result section, all the relevant images are retrieved from the database when the first seven images are retrieved.

### VIII. RESULTS

In the experiment various images are used in the MATLAB program. The results of different medical test images are shown below. The Query Image is given at top left in the examples. Its similarity measure is equal to 1 and the images similar to the query image are displayed with the respective similarity distances. S defines the similarity measurement and the coefficient of S indicates the image number. For the given database images 2-level DWT and Harris detector are applied and the calculations i.e, required energy and distance are calculated and stored. Database consists of different medical images with the same characteristics. For the given query image also 2- level DWT is applied and the images relevant to the query image are sorted and displayed. Some of the examples are shown below with the relevant retrieved images.

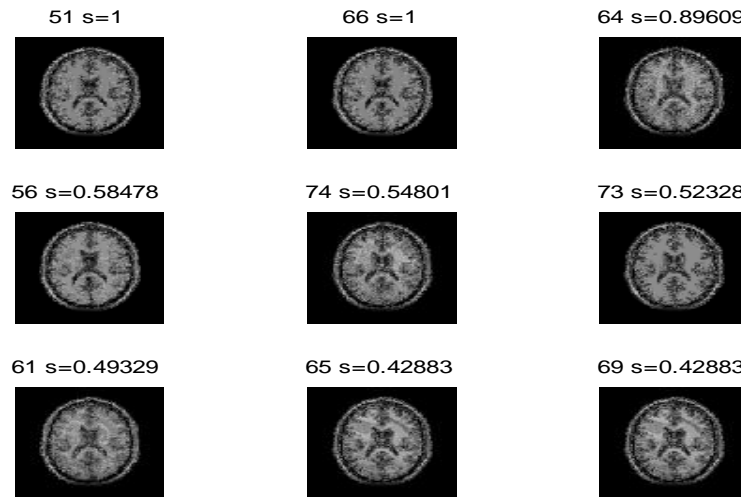

Fig.4. Retrieve images for a sample query of 51 in the database using DWT

As shown in fig.4. top of the image as query image(i.e. first image in first row) and S is the similarity measurement.

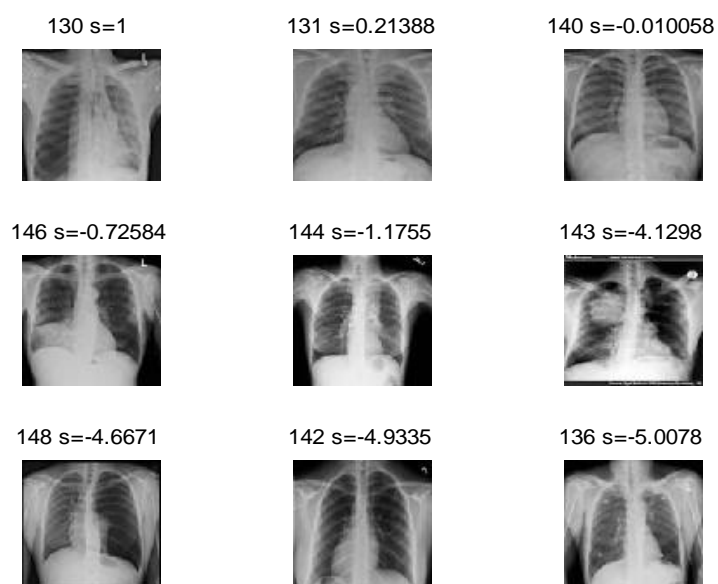

Fig.5. Retrieve images for a sample query of 130 in the database using DWT

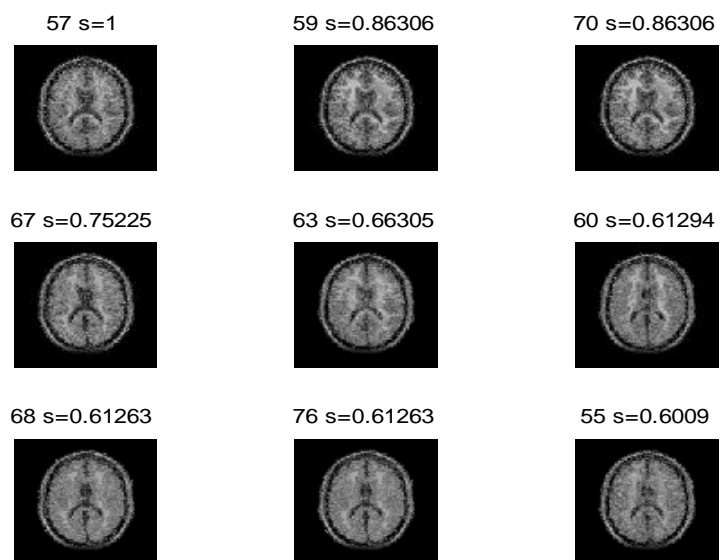

Fig.6. Retrieve images for a sample query of 79 in the database using Harris detector

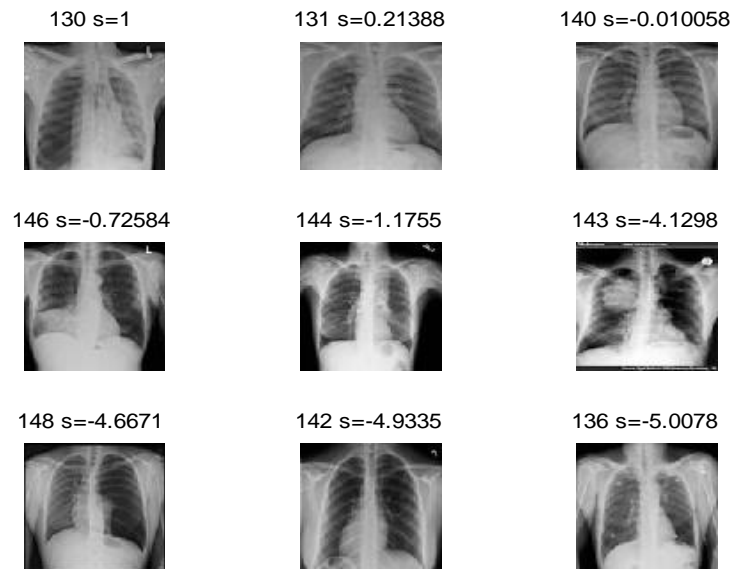

Fig.7. Retrieve images for a sample query of 130 in the database using Harris detector

## IX. CONCLUSION

This paper attempts to evaluate the performance of the CBIR system on sample datasets of medical images using 2-level DWT. DWT is the development of wavelet transform and construct wavelet with two scaling function. The system gives good results on the tests conducted. Further tests must be conducted on various and large databases to have a more accurate evaluation. The indexation technique is a crucial part in a CBIR system. To have a more powerful and efficient retrieval system for image and multimedia databases, content based queries must be combined with text and keyword predicates.

## REFERENCES

- [1]. J Eakins, M E Graham, Content-based Image Retrieval, A report to the JISC Technology Applications Programme, 1999.
- [2]. Thomas S. Huang, Yong Rui, and Shinh-Fu Chang, Image retrieval: Past, Present and Future, International Symposium on Multimedia Information Processing, 1997.
- [3]. M. Myron Flickner, H. Sawhney, W. Niblack, J. Ashley, Q. Huang, B. Dom, M. Gorkani, J. Hafner, D. Lee, D.Petkovic, D.Steele and P.Yanker, "Query by image content: The QBIC system", In IEEE Computer, pp. 23-31, Sept.1995
- [4]. Patrick M. Kelly, Michael Cannon and Donald R. Hush, Query by Image Example: The CANDID approach. In Storage and Retrieval for Image and Video Databases III, volume 2420, pp 238-248, SPIE, 1995
- [5]. Chad Carson, Serge Belongie, Hayit Greenspan, Jitendra Malik, Blobworld: Image segmentation using Expectation-Maximization and its application to image querying, Third International Conference on Visual Information Systems, 1999
- [6]. M. Das, E. M. Riseman, and B. A. Draper. Focus: Searching for multi-colored objects in a diverse image database, In IEEE Conference on Computer Vision and Pattern Recognition, pp 756-761, Jun 1997